

DEAN PUMP® SERIES RA

Fan Cooled Hot Oil Pumps

DATA PAK

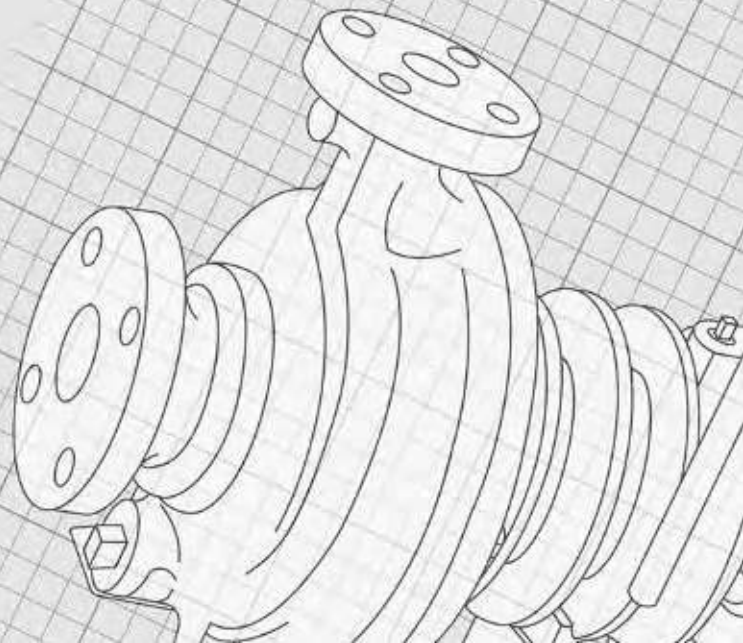
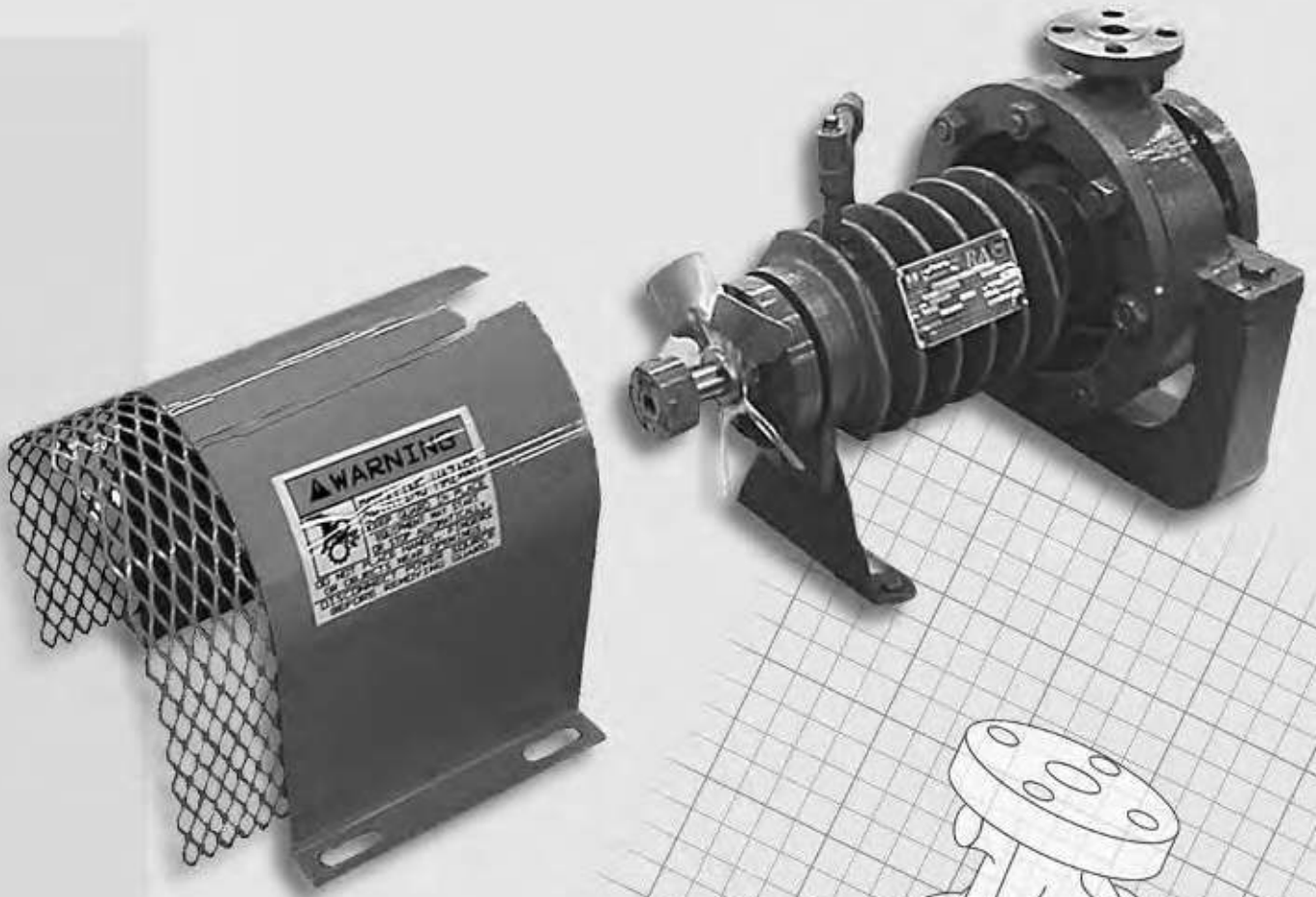

(317) 293-2930 • E-mail: info@deanpump.com

FAN COOLED, HORIZONTAL, SINGLE STAGE, END SUCTION, ENCLOSED IMPELLER, CENTRIFUGAL, HOT OIL PUMPS

MECHANICAL DESIGN SPECIFICATIONS

PUMP TYPE	RA2096	RA3146	RA3186
Direction of Rotation (Viewed from Coupling End)	CW	CCW	CCW
Casing Thickness, Minimum	5/16"	5/16"	5/16"
Corrosion Allowance	1/8"	1/8"	1/8"
Impeller Balance Standard Optional Extra	Single Plane Dynamic	Single Plane Dynamic	Single Plane Dynamic
Flanges ANSI Class Facing Finish	150 Flat Face 125 Ra	300 Raised Face 125 Ra	300 Raised Face 125 Ra
Suction Pressure, Maximum	100 PSIG	100 PSIG	100 PSIG
Horsepower Rating, Maximum @3500 RPM @1750 RPM @1150 RPM	35 15 10	100 40 25	250 125 75
Bearings: Thrust Bearing, Ball Type, Grease Lubricated Radial Bearing, Sleeve Type, Pumpage Lubricated	5306 2RS Double Row	7308 BG Angular Contact Pair	7311 BG Angular Contact Pair
Seal Chamber Dimensions Length (Depth) Inside Diameter (Bore Dia.) Shaft Diameter	1 5/8" 2 1/16" 1 1/8"	2 13/16" 3 1/8" 1 3/4"	3 7/8" 4 5/16" 2 1/4"
Pump Shaft Dimensions Span Between Bearings Span Between Radial Bearing Centerline and Impeller Centerline Diameter at Coupling Diameter Between Bearings Diameter at Impeller	8 11/16" 1 5/8" 7/8" 15/16" 3/4"	11 7/16" 2 5/16" 1 1/8" 1 9/16" 1 1/8"	14 5/8" 3 1/4" 1 5/8" 1 7/8" 1 1/8"
L ³ /D ⁴	4.3	2.1	2.8
Material Class	22 (Ductile Iron)	22 (Ductile Iron)	22 (Ductile Iron)
Maximum Working Pressure	250 PSIG @100°F	350 PSIG	350 PSIG
Pumping Temperature Minimum Maximum	-20°F @250 PSIG 650°F @125 PSIG	-20°F 650°F	-20°F 650°F
Maximum Ambient Temperature (temp. within 12" of pump)	104°F	118°F	118°F
Hydrostatic Test Pressure	430 PSIG	550 PSIG	550 PSIG

THESE PUMPS ARE DESIGNED SPECIFICALLY FOR USE WITH HEAT TRANSFER OILS. THESE PUMPS WILL NOT WORK ON OTHER LIQUIDS.

STANDARD MATERIALS OF CONSTRUCTION

Part No.	Part Name	RA2096 Class 22	RA3146 Class 22	RA3186 Class 22
3	Impeller	C.I. (1)	C.I. (1)	C.I. (1)
*4	Impeller Key	Steel (2)	Steel (2)	Steel (2)
5	Casing	D.I. (10)	D.I. (10)	D.I. (10)
5A	Casing Drain Plug	Steel (2)	Steel (2)	Steel (2)
5C	Casing Stud Nut	N.A.	Steel (5)	Steel (5)
5D	Casing Stud/Cap Screw	Steel (3) Screw	Steel (4) Stud	Steel (4) Stud
6A	Casing Ring (Only Some Sizes)	N.A.	Iron (7)	Iron (7)
9	Bearing Housing Foot	Steel (2)	Steel (2)	Steel (2)
*12	Impeller Bolt/Nut	Steel (2) Nut	Steel (2) Bolt	Steel (2) Bolt
*12A	Impeller Washer	Steel (2)	Steel (2)	Steel (2)
*13	Mechanical Seal Gland	Steel (2)	Steel (2)	Steel (2)
*25A	Shaft Bearing – Thrust – Ball	Double Row	Angular Contact Pair	Angular Contact Pair
26	Bearing Housing	D.I. (10)	D.I. (10)	D.I. (10)
*28	Bearing End Cover	C.I. (1)	Steel (2)	D.I. (9)
*29	Pump Shaft	11-13 S/S (12)	11-13 S/S (12)	11-13/316 S/S (8)
*31	Thrust Bearing Lock Nut	N.A.	Steel (2)	Steel (2)
*31A	Thrust Bearing Lock Washer	N.A.	Steel (2)	Steel (2)
56	Casing Foot	N.A.	C.I. (1)	C.I. (1)
*75	Snap Ring	N.A.	Steel (2)	N.A.
*75A	Snap Ring	Steel (2)	N.A.	N.A.
*76	Grease Seal – Front	Viton (13)	Viton (13)	Viton (13)
*76A	Grease Seal – Rear	N.A.	Buna (14)	Buna (14)
77	Casing Gasket	Grafoil (11)	Grafoil (11)	Grafoil (11)
*77B	Bearing End Cover Gasket	N.A.	Buna (14)	Buna (14)
*84	Barrier Oil Fill Plug	Steel (2)	Steel (2)	Steel (2)
*92	Barrier Oil Drain Plug	Steel (2)	Steel (2)	Steel (2)
*95A	Mechanical Seal Stationary	Silicon Carbide & Viton	Silicon Carbide & Viton	Silicon Carbide & Viton
*95B	Mechanical Seal Rotary	S/S, Carbon & Viton	S/S, Carbon & Viton	S/S, Carbon & Viton
98	Coupling Guard	Steel (2)	Steel (2)	Steel (2)
*120	Fan	Aluminum	Aluminum	Aluminum
*121	Fan Collar	N.A.	Steel (2)	Steel (2)
*122	Fan Clamp Ring	Steel (2)	Steel (2)	Steel (2)
*180	Radial Bearing Cartridge	Carbon & Steel	Carbon & Steel	Carbon & 416 S/S
*325	Seal Gland Gasket	Viton (13)	Viton (13)	Viton (13)
*365	Mechanical Seal Retainer	Steel (2)	Steel (2)	Steel (2)
*370	Seal Retainer Set Screw	Steel	Steel	Steel
*375	Anti-Rotation Pin	N.A.	N.A.	316 S/S

ALLOWABLE WORKING PRESSURE VS. PUMPING TEMPERATURE

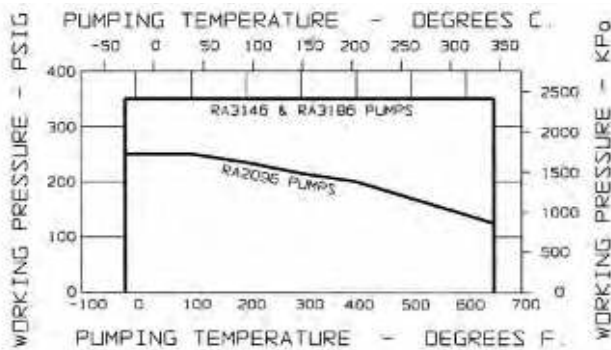

*Denotes parts interchangeability in all pump sizes of a given series.

- | | |
|---|--|
| (1) Cast Iron | (8) ANSI 316 S/S with ANSI 416 S/S at the sleeve bearing |
| (2) AISI 1020 | (9) Ductile Iron – ASTM A536 |
| (3) SAE Grade 5 or ASTM A449 Type 1 Steel | (10) Ductile Iron – ASTM A395 |
| (4) AISI 4140 ASTM A193-B7 Steel | (11) Grafoil® |
| (5) ASTM A194 Grade 2 Steel | (12) ANSI – 420 S/S |
| (7) Hardened Iron | (13) Viton® Elastomer |
| | (14) Buna N Rubber |

Viton® is a registered Trademark of E.I. DuPont Co.
Grafoil® is a registered Trademark of Union Carbide Corp.

RA SERIES PUMP PERFORMANCE

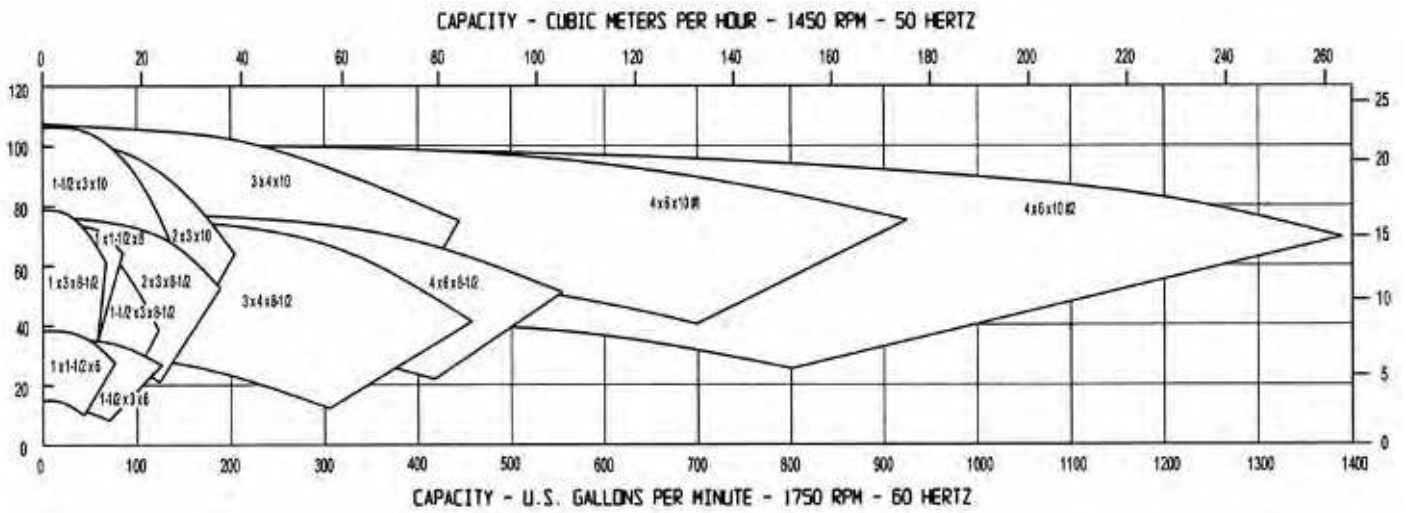
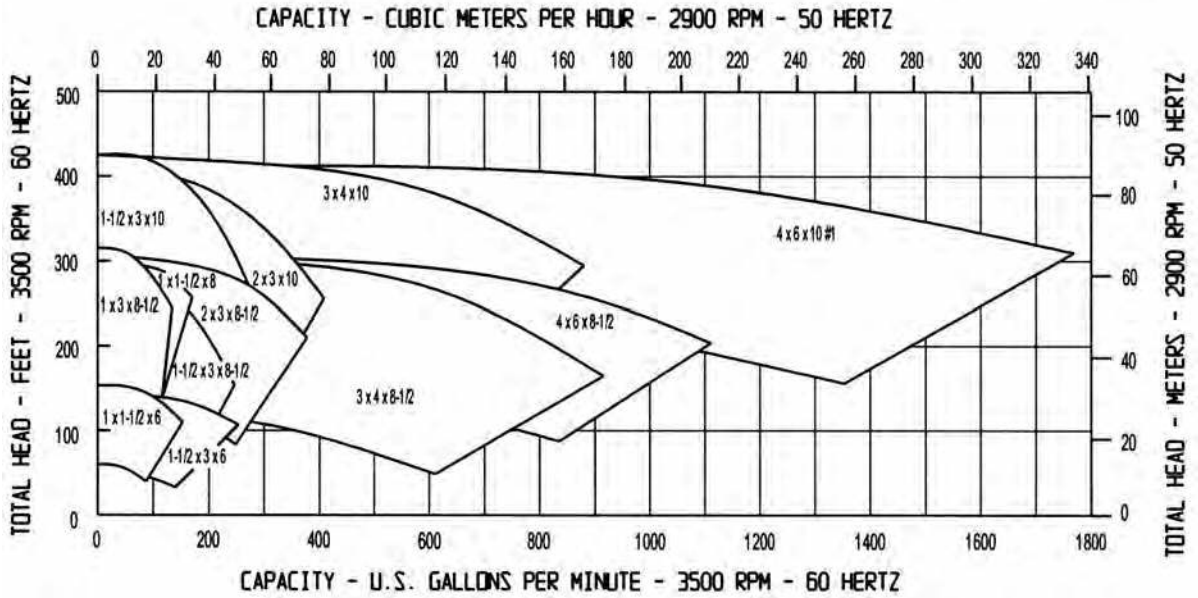

RA-2096 WITH SHAFT FAN

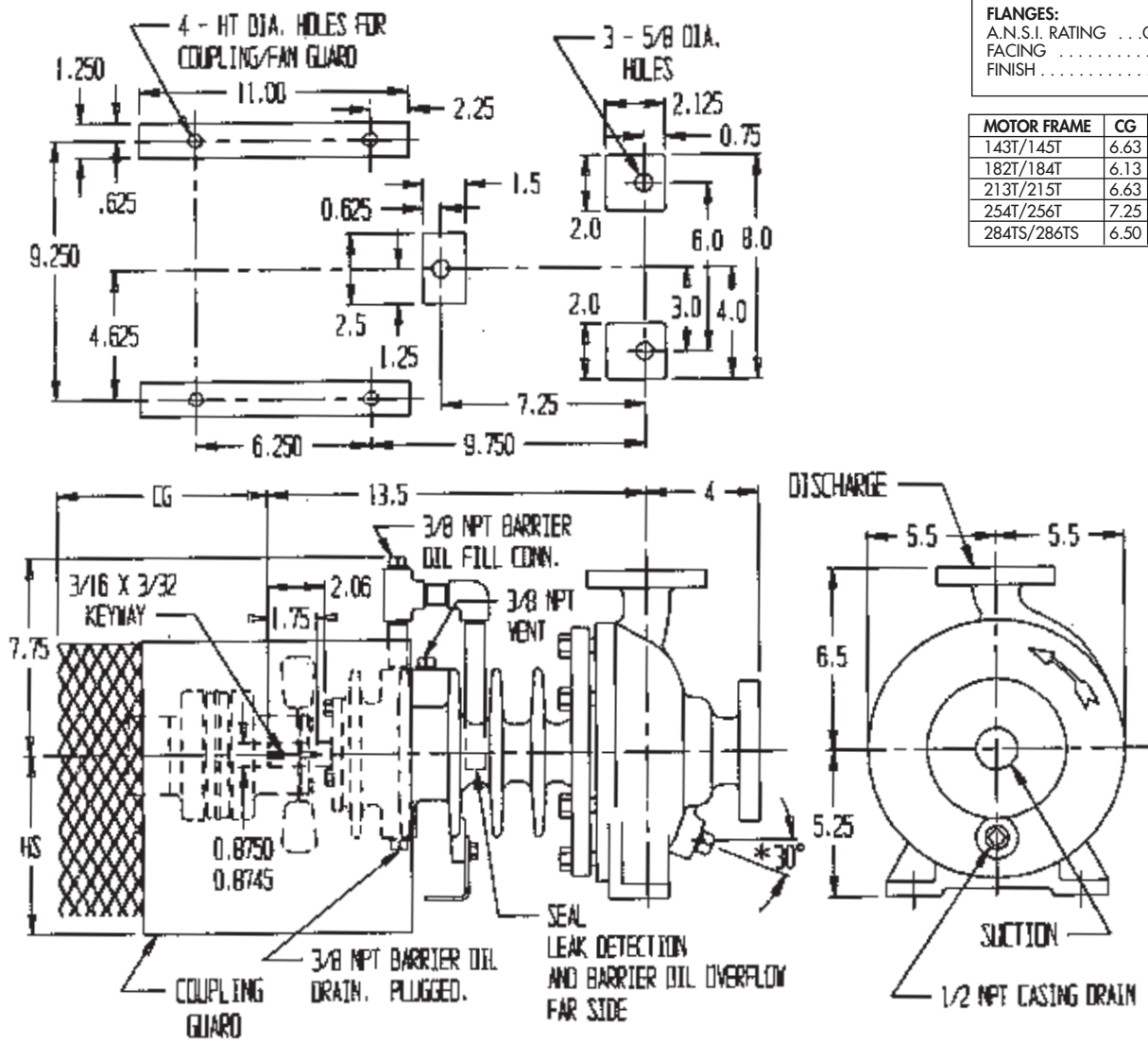

FLANGES:
A.N.S.I. RATING ... Class 150
FACING Flat Face
FINISH 125 Ra

MOTOR FRAME	CG	HS	HT
143T/145T	6.63	5.25	0.38
182T/184T	6.13	5.25	0.38
213T/215T	6.63	5.25	0.38
254T/256T	7.25	6.25	0.50
284TS/286TS	6.50	7.00	0.50

PUMP SIZE	DISCHARGE					SUCTION				
	SIZE	O.D.	THK	B.C.	BOLTS	SIZE	O.D.	THK	B.C.	BOLTS
1 x 1 1/2 x 6	1	4 1/4	9/16	3 1/8	4-1/2	1 1/2	5	1 1/16	3 7/8	4-1/2
*1 1/2 x 3 x 6	1 1/2	5	1 1/16	3 7/8	4-1/2	3	7 1/2	1 5/16	6	4-5/8
1 x 1 1/2 x 8	1	4 1/4	9/16	3 1/8	4-1/2	1 1/2	5	1 1/16	3 7/8	4-1/2

All dimensions in inches

IMPORTANT: Do not use for construction unless certified.

DIMENSION DWG.
NO. RA-1103

RA-2096 WITH SHAFT FAN

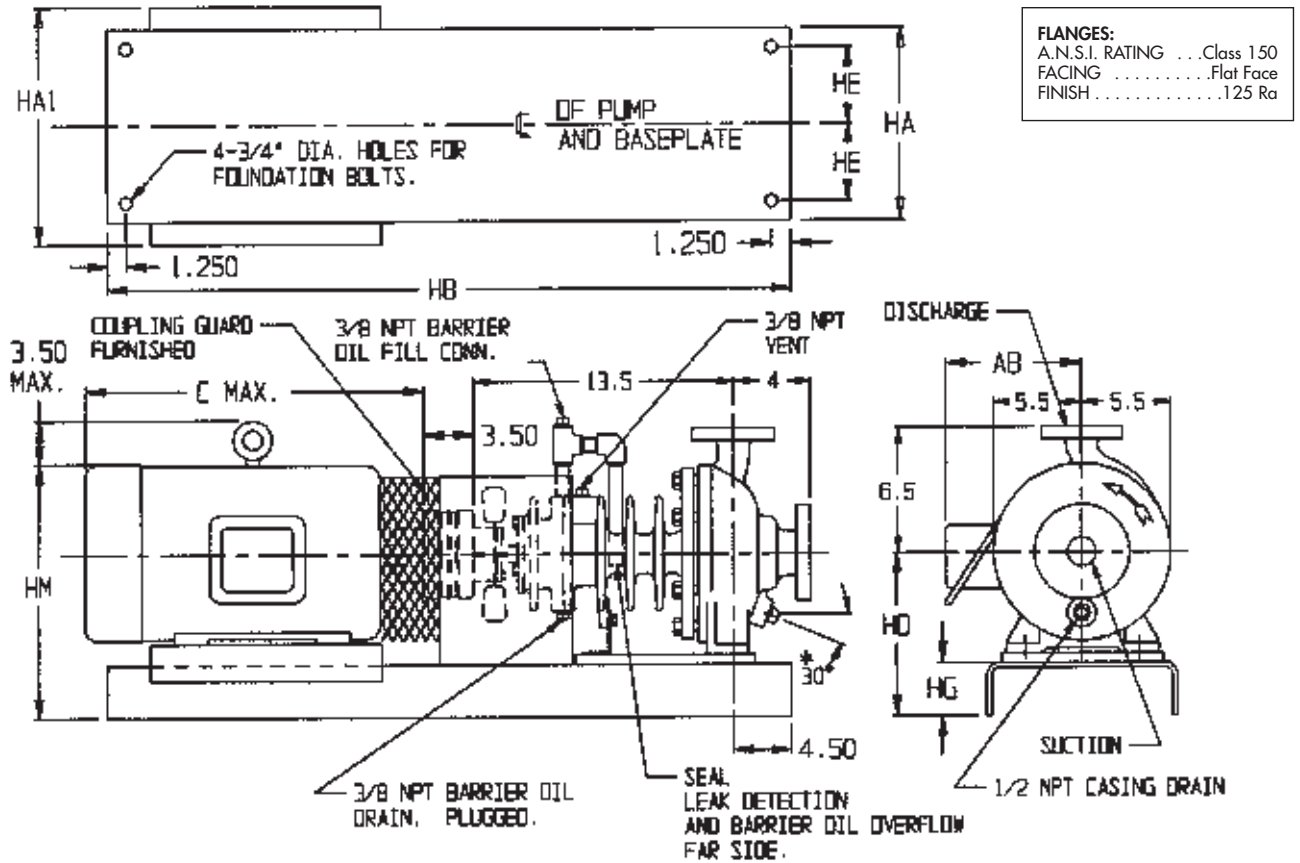

PUMP SIZE	DISCHARGE					SUCTION				
	SIZE	O.D.	THK	B.C.	BOLTS	SIZE	O.D.	THK	B.C.	BOLTS
1 x 1 1/2 x 6	1	4 1/4	9/16	3 1/8	4-1/2	1 1/2	5	11/16	3 7/8	4-1/2
*1 1/2 x 3 x 6	1 1/2	5	11/16	3 7/8	4-1/2	3	7 1/2	15/16	6	4-5/8
1 x 1 1/2 x 8	1	4 1/4	9/16	3 1/8	4-1/2	1 1/2	5	11/16	3 7/8	4-1/2

All dimensions in inches

FRAME	C	AB	HA	HA ₁	HB	HD	HE	HG	HM
143T	13 1/4	6 1/2	12	—	39	8 1/2	4 1/2	3 1/4	12 1/4
145T	13 3/4	6 1/2	12	—	39	8 1/2	4 1/2	3 1/4	12 1/4
182T	14 5/8	7 1/2	12	—	39	8 1/2	4 1/2	3 1/4	13 1/4
184T	15 5/8	7 1/2	12	—	39	8 1/2	4 1/2	3 1/4	13 1/4
213T	18 1/8	9 1/2	12	—	39	8 1/2	4 1/2	3 1/4	14 1/4
215T	19 5/8	9 1/2	12	—	39	8 1/2	4 1/2	3 1/4	14 1/4
254T	23 1/8	11	15	—	52	10 3/8	6	4 1/8	17 3/8
256T	24 7/8	11	15	—	52	10 3/8	6	4 1/8	17 3/8
284TS	25 1/2	12 5/8	15	—	52	11 1/8	6	4 1/8	18 7/8
286TS	27	12 5/8	15	—	52	11 1/8	6	4 1/8	18 7/8
324TS	28 3/8	14 3/4	12	16 1/2	45	13 3/4	4 1/2	3 3/4	22 1/2

IMPORTANT: Do not use for construction unless certified.

**DIMENSION DWG.
NO. RA-1123**

RA-3146 WITH SHAFT FAN

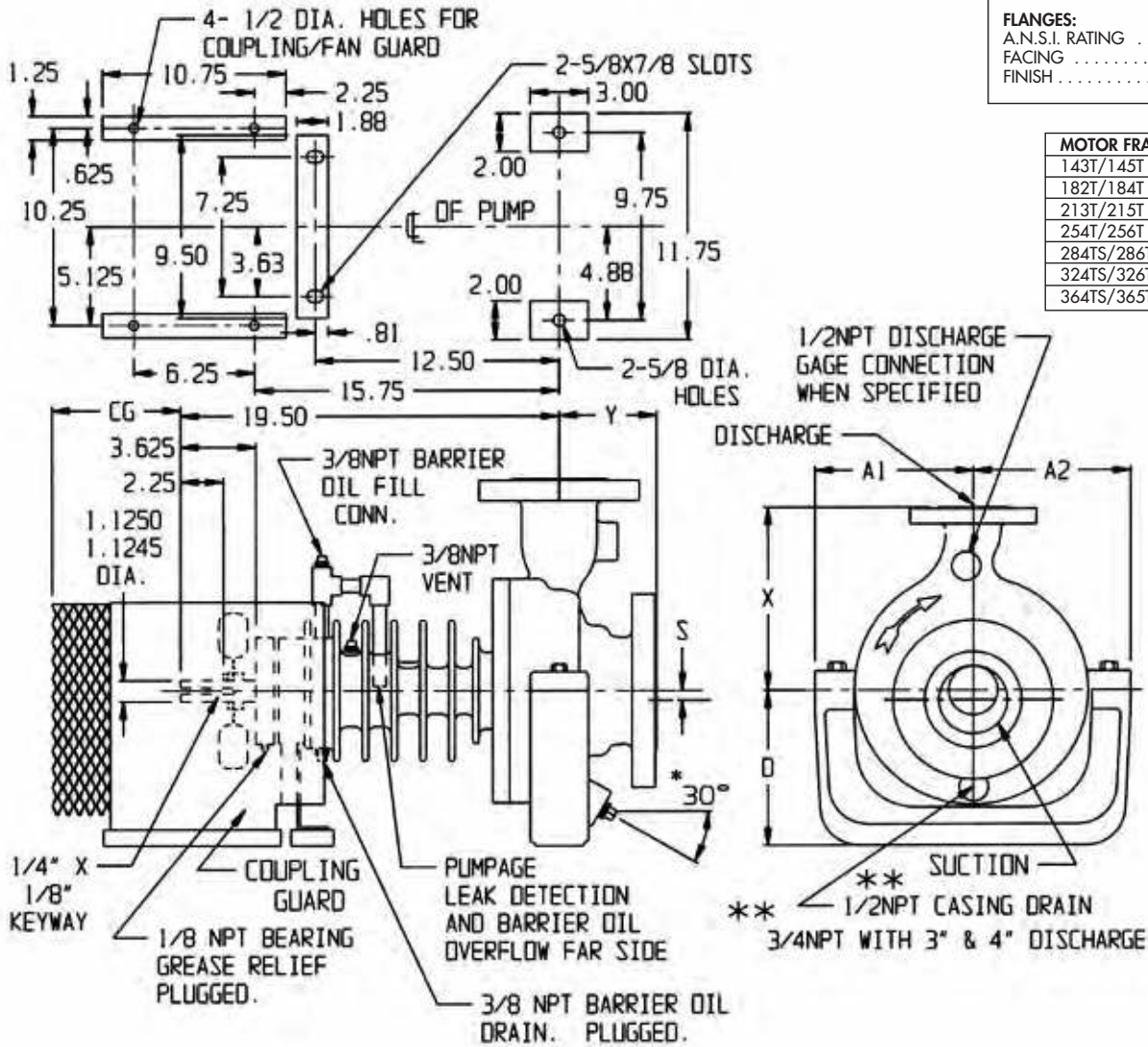

FLANGES:
A.N.S.I. RATING ... Class 300
FACING Raised Face
FINISH 125 Ra

MOTOR FRAME	CG
143T/145T	6.81
182T/184T	6.13
213T/215T	6.63
254T/256T	7.25
284TS/286TS	6.50
324TS/326TS	7.13
364TS/365TS	7.13

** 3/4" NPT with 3" and 4" discharge

PUMP SIZE	DISCHARGE					SUCTION					A ₁	A ₂	D	S	X	Y
	SIZE	O.D.	THK	B.C.	BOLTS	SIZE	O.D.	THK	B.C.	BOLTS						
*1 x 3 x 8 1/2	1	4 7/8	1 1/16	3 1/2	4-5/8	3	8 1/4	1 1/8	6 5/8	8-3/4	8 1/8	8 1/8	8 1/4	0	7 1/2	4
1 1/2 x 3 x 8 1/2	1 1/2	6 1/8	1 3/16	4 1/2	4-3/4	3	8 1/4	1 1/8	6 5/8	8-3/4	8 1/8	8 1/8	8 1/4	0	8 1/2	4
2 x 3 x 8 1/2	2	6 1/2	7/8	5	8-5/8	3	8 1/4	1 1/8	6 5/8	8-3/4	8 1/8	8 1/8	8 1/4	0	9 1/2	5
*3 x 4 x 8 1/2	3	8 1/4	1 1/8	6 5/8	8-3/4	4	10	1 1/4	7 7/8	8-3/4	9	8 1/8	10	0	11	5
*4 x 6 x 8 1/2	4	10	1 1/4	7 7/8	8-3/4	6	12 1/2	1 7/16	10 5/8	12-3/4	10 1/4	8 1/8	10	5/8	11 1/2	6
1 1/2 x 3 x 10	1 1/2	6 1/8	1 3/16	4 1/2	4-3/4	3	8 1/4	1 1/8	6 5/8	8-3/4	9	8 3/4	10	0	9	4
2 x 3 x 10	2	6 1/2	7/8	5	8-5/8	3	8 1/4	1 1/8	6 5/8	8-3/4	9	8 3/4	10	0	9 1/2	5
3 x 4 x 10	3	8 1/4	1 1/8	6 5/8	8-3/4	4	10	1 1/4	7 7/8	8-3/4	10 3/8	8 3/4	10	0	11	5
4 x 6 x 10 #2	4	10	1 1/4	7 7/8	8-3/4	6	12 1/2	1 7/16	10 5/8	12-3/4	11 3/4	10	1 1/2	1/8	12 1/2	6

All dimensions in inches

IMPORTANT: Do not use for construction unless certified.

DIMENSION DWG.
NO. RA-1003

RA-3146 WITH SHAFT FAN

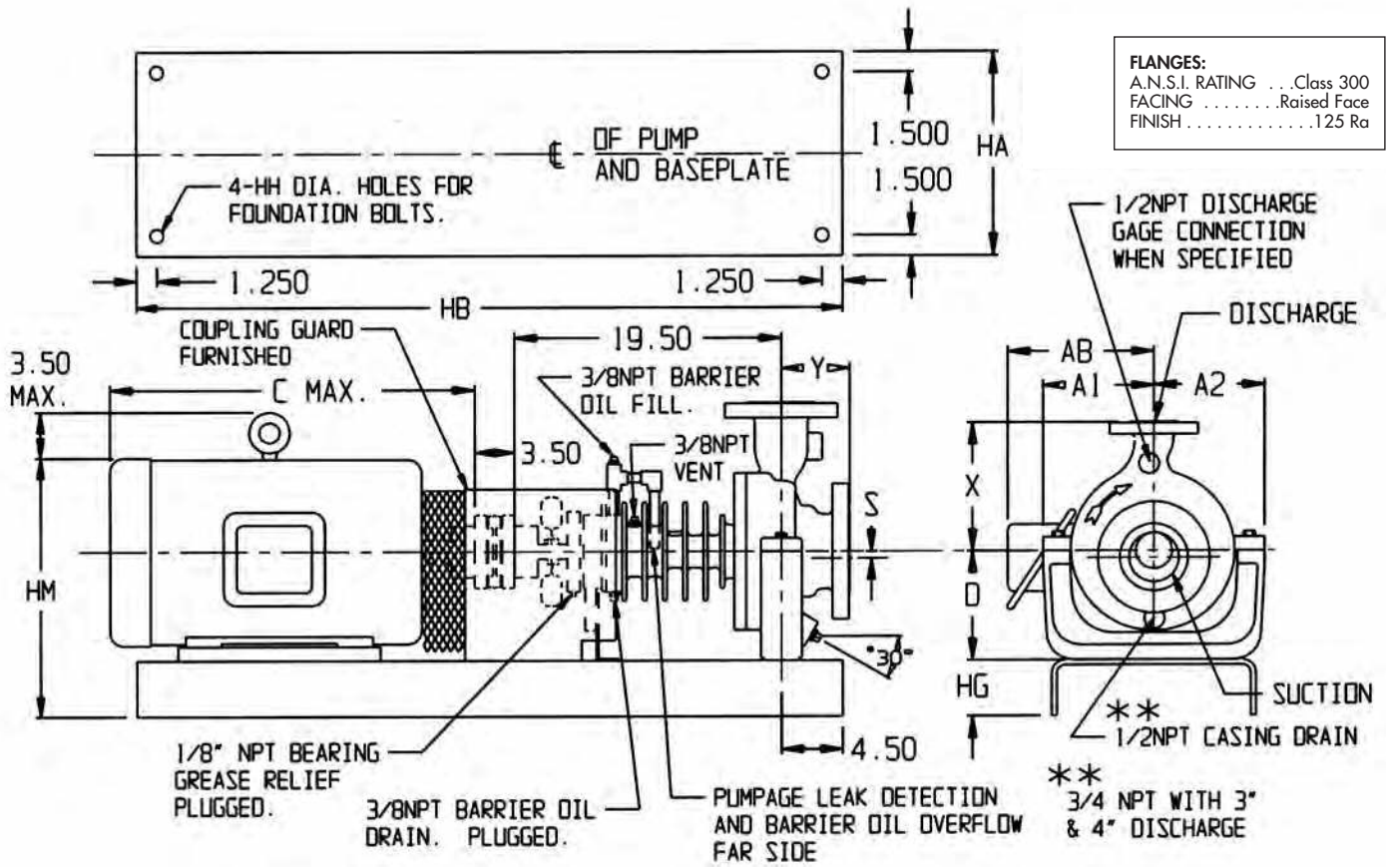

** 3/4" NPT with 3" and 4" discharge

PUMP SIZE	DISCHARGE					SUCTION					A ₁	A ₂	D	S	X	Y
	SIZE	O.D.	THK	B.C.	BOLTS	SIZE	O.D.	THK	B.C.	BOLTS						
*1 x 3 x 8 1/2	1	4 7/8	1 1/16	3 1/2	4-5/8	3	8 1/4	1 1/8	6 5/8	8-3/4	8 1/8	8 1/8	8 1/4	0	7 1/2	4
1 1/2 x 3 x 8 1/2	1 1/2	6 1/8	1 3/16	4 1/2	4-3/4	3	8 1/4	1 1/8	6 5/8	8-3/4	8 1/8	8 1/8	8 1/4	0	8 1/2	4
2 x 3 x 8 1/2	2	6 1/2	7/8	5	8-5/8	3	8 1/4	1 1/8	6 5/8	8-3/4	8 1/8	8 1/8	8 1/4	0	9 1/2	5
*3 x 4 x 8 1/2	3	8 1/4	1 1/8	6 5/8	8-3/4	4	10	1 1/4	7 7/8	8-3/4	9	8 1/8	10	0	11	5
*4 x 6 x 8 1/2	4	10	1 1/4	7 7/8	8-3/4	6	12 1/2	1 7/16	10 5/8	12-3/4	10 1/4	8 1/8	10	5/8	11 1/2	6
1 1/2 x 3 x 10	1 1/2	6 1/8	1 3/16	4 1/2	4-3/4	3	8 1/4	1 1/8	6 5/8	8-3/4	9	8 3/4	10	0	9	4
2 x 3 x 10	2	6 1/2	7/8	5	8-5/8	3	8 1/4	1 1/8	6 5/8	8-3/4	9	8 3/4	10	0	9 1/2	5
3 x 4 x 10	3	8 1/4	1 1/8	6 5/8	8-3/4	4	10	1 1/4	7 7/8	8-3/4	10 3/8	8 3/4	10	0	11	5
4 x 6 x 10 #2	4	10	1 1/4	7 7/8	8-3/4	6	12 1/2	1 7/16	10 5/8	12-3/4	11 3/4	10	11 1/2	1/8	12 1/2	6

All dimensions in inches

FRAME	C	AB	HA	HB	HG	HH	HM			FRAME	C	AB	HA	HB	HG	HH	HM		
							D=8 1/4	D=10	D=11 1/2								D=8 1/4	D=10	D=11 1/2
143T	13 1/4	6 1/2	12	45	3 3/4	3/4	15 7/8	17 5/8	19 1/8	286T	28 3/8	12 5/8	15	52	4 1/8	3/4	20 1/8	21 7/8	23 3/8
145T	13 3/4	6 1/2	12	45	3 3/4	3/4	15 7/8	17 5/8	19 1/8	286TS	27	12 5/8	15	52	4 1/8	3/4	20 1/8	21 7/8	23 3/8
182T	14 5/8	7 1/2	12	45	3 3/4	3/4	17 1/4	19	20 1/2	324T	29 7/8	14 3/4	18	58	4 3/4	1	21 3/4	23 1/2	25
184T	15 5/8	7 1/2	12	45	3 3/4	3/4	17 1/4	19	20 1/2	324TS	28 3/8	14 3/4	18	58	4 3/4	1	21 3/4	23 1/2	25
213T	18 1/8	9 1/2	12	45	3 3/4	3/4	18	19 3/4	21 1/4	326T	31 3/8	14 3/4	18	58	4 3/4	1	21 3/4	23 1/2	25
215T	19 5/8	9 1/2	12	45	3 3/4	3/4	18	19 3/4	21 1/4	326TS	29 7/8	14 3/4	18	58	4 3/4	1	21 3/4	23 1/2	25
254T	23 1/8	10 3/4	15	52	4 1/8	3/4	19 3/8	21 1/8	22 5/8	364T	33 1/8	15 5/8	18	58	4 3/4	1	—	24 5/8	—
256T	24 7/8	10 3/4	15	52	4 1/8	3/4	19 3/8	21 1/8	22 5/8	364TS	31 1/2	15 5/8	18	58	4 3/4	1	—	24 5/8	—
284T	26 7/8	12 5/8	15	52	4 1/8	3/4	20 1/8	21 7/8	23 3/8	365T	34 1/8	15 5/8	18	58	4 3/4	1	—	24 5/8	—
284TS	25 1/2	12 5/8	15	52	4 1/8	3/4	20 1/8	21 7/8	23 3/8	365TS	32 1/2	15 5/8	18	58	4 3/4	1	—	24 5/8	—

IMPORTANT: Do not use for construction unless certified.

DIMENSION DWG.
NO. RA-1023

RA-3186 WITH SHAFT FAN

FLANGES:
A.N.S.I. RATING . . . Class 300
FACING Raised Face
FINISH 125 Ra

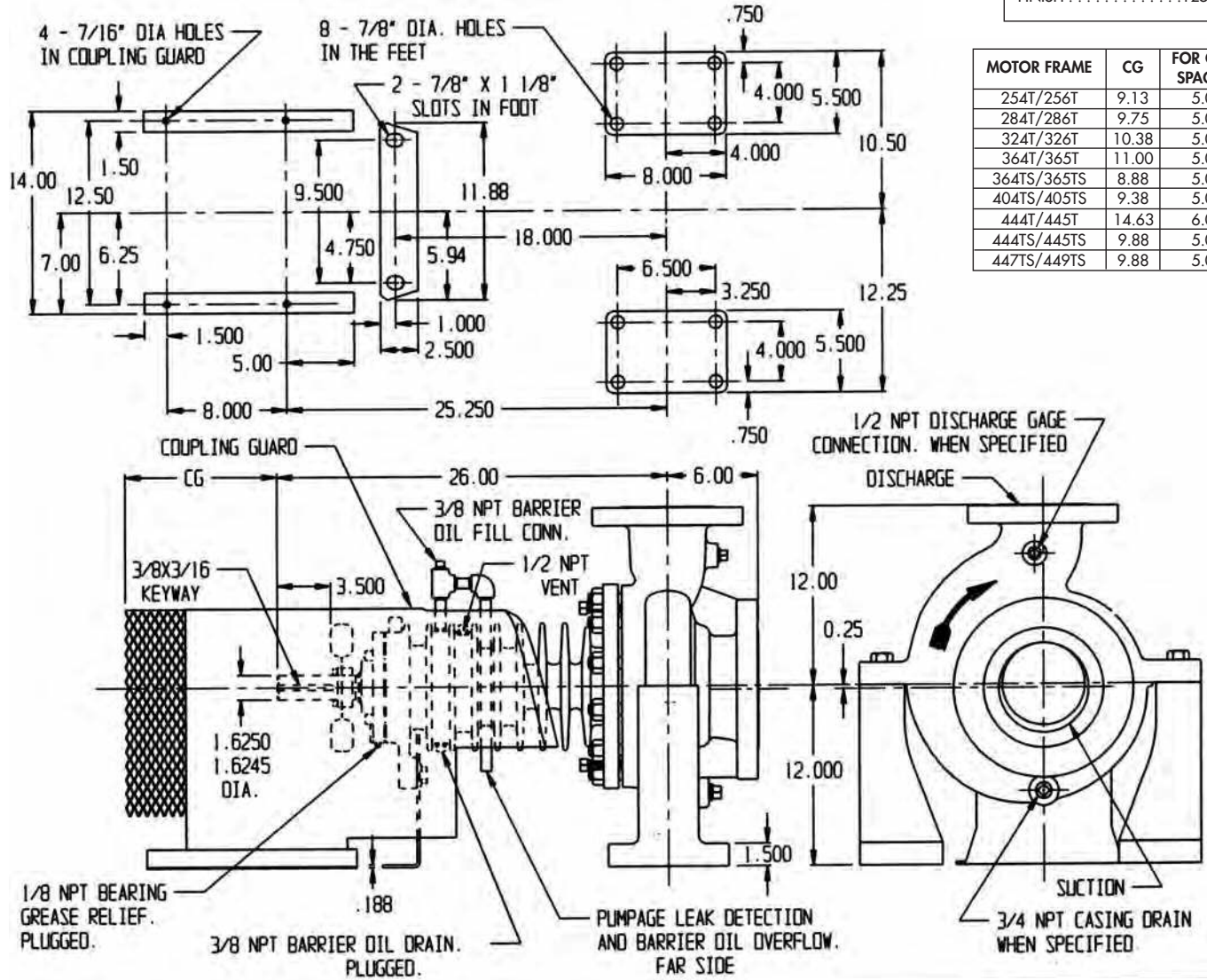

MOTOR FRAME	CG	FOR CPL. SPACER
254T/256T	9.13	5.0
284T/286T	9.75	5.0
324T/326T	10.38	5.0
364T/365T	11.00	5.0
364TS/365TS	8.88	5.0
404TS/405TS	9.38	5.0
444T/445T	14.63	6.0
444TS/445TS	9.88	5.0
447TS/449TS	9.88	5.0

PUMP SIZE	DISCHARGE					SUCTION				
	SIZE	O.D.	THK	B.C.	BOLTS	SIZE	O.D.	THK	B.C.	BOLTS
4 x 6 x 10 #1	4	10	1 1/4	7 7/8	8 - 3/4	6	12 1/2	1 7/16	10 5/8	12 - 3/4

All dimensions in inches

RA-3186 WITH SHAFT FAN

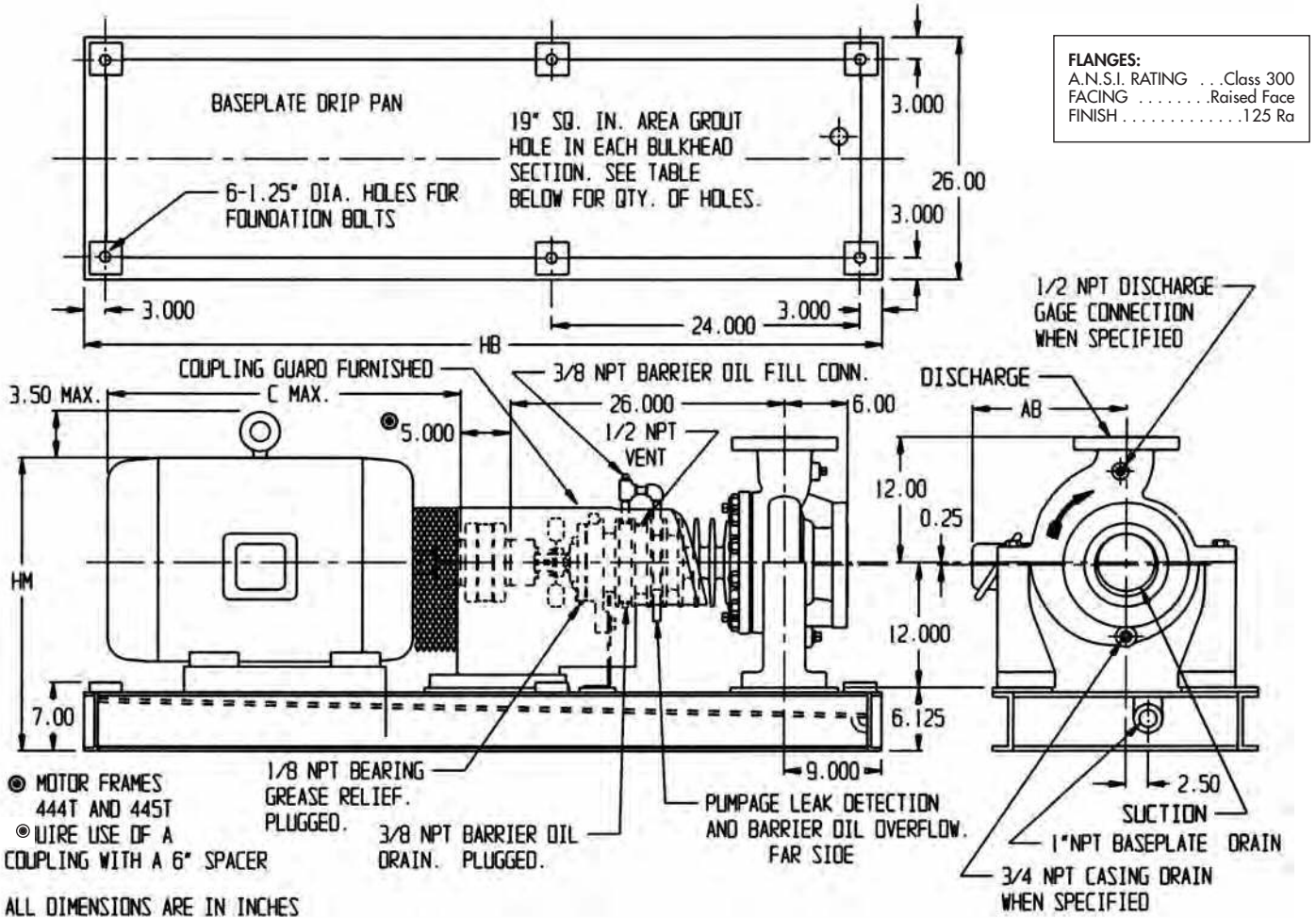

PUMP SIZE	DISCHARGE					SUCTION				
	SIZE	O.D.	THK	B.C.	BOLTS	SIZE	O.D.	THK	B.C.	BOLTS
4 x 6 x 10 #1	4	10	1 1/4	7 7/8	8-3/4	6	12 1/2	1 7/16	10 5/8	12-3/4

All dimensions in inches

FRAME	C	AB	HB	HM	QTY. OF GROUT HOLES
254T	22 7/8	11	68	24 7/8	3
256T	24 3/4	11	68	24 7/8	3
284T	26 3/4	12 3/4	68	25 5/8	3
286T	28 1/4	12 3/4	68	25 5/8	3
324TS	28 1/4	14 3/4	72	26 5/8	3
324T	29 3/4	14 3/4	72	26 5/8	3
326TS	29 3/4	14 3/4	72	26 5/8	3
326T	31 1/4	14 3/4	72	26 5/8	3
364TS	31 1/4	16 1/4	72	27 7/8	3

FRAME	C	AB	HB	HM	QTY. OF GROUT HOLES
364T	32 7/8	16 1/4	72	27 7/8	3
365TS	32 1/4	16 1/4	72	27 7/8	3
365T	33 7/8	16 1/4	72	27 7/8	3
404TS	33 1/2	17 1/2	78	28 7/8	5
404T	36 1/2	17 1/2	78	28 7/8	5
405TS	35	17 1/2	78	28 7/8	5
405T	38	17 1/2	78	28 7/8	5
444TS	38 1/2	18 1/2	82	30 3/8	5
445TS	40 1/2	18 1/2	82	30 3/8	5

IMPORTANT: Do not use for construction unless certified.

**DIMENSION DWG.
NO. RA-2032**

PUMP PERFORMANCE: This curve, based on extensive tests, defines the average performance of this pump for liquids having a viscosity of 70 SSU or less. Actual performance of individual units may differ slightly from the performance indicated on this curve. Pump applications made from the data contained herein are subject to confirmation and acceptance by our Engineering Department at our Indianapolis Office.

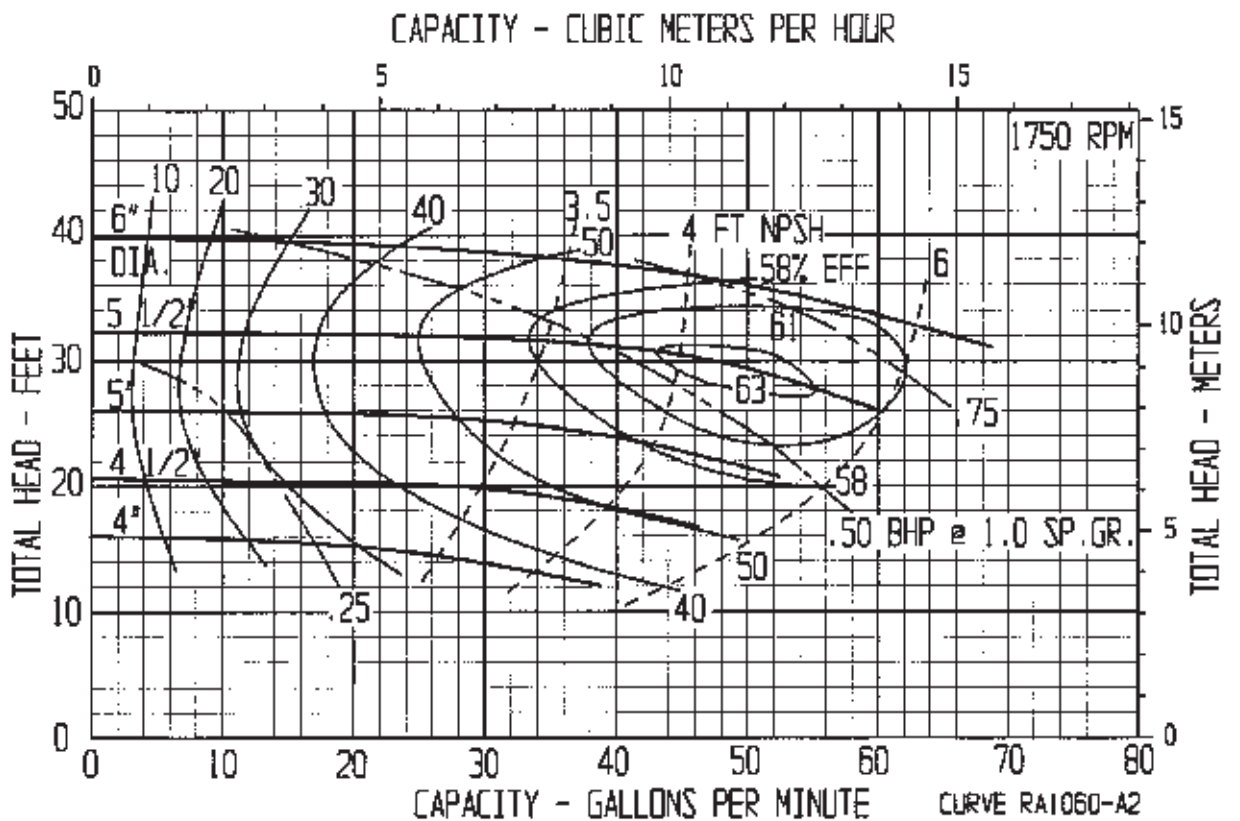
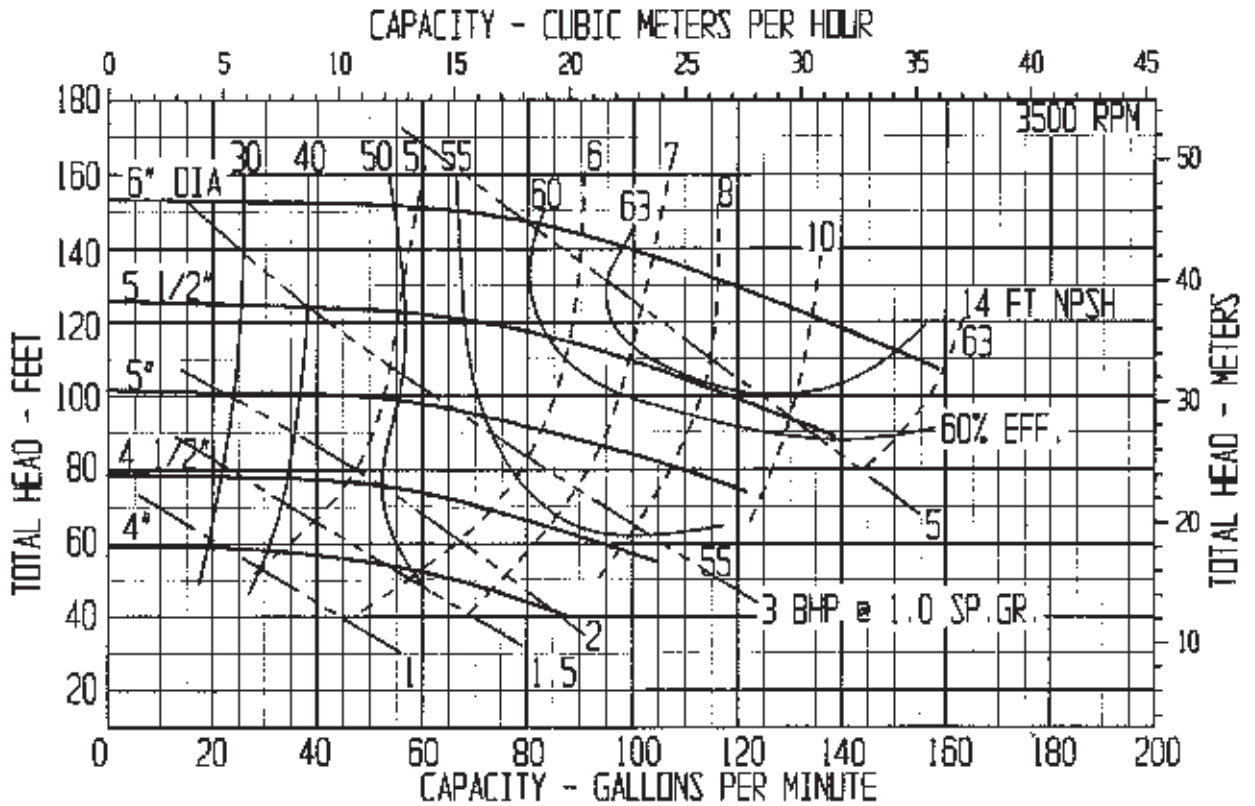

CURVE RA1060-A2

PUMP PERFORMANCE: This curve, based on extensive tests, defines the average performance of this pump for liquids having a viscosity of 70 SSU or less. Actual performance of individual units may differ slightly from the performance indicated on this curve. Pump applications made from the data contained herein are subject to confirmation and acceptance by our Engineering Department at our Indianapolis Office.

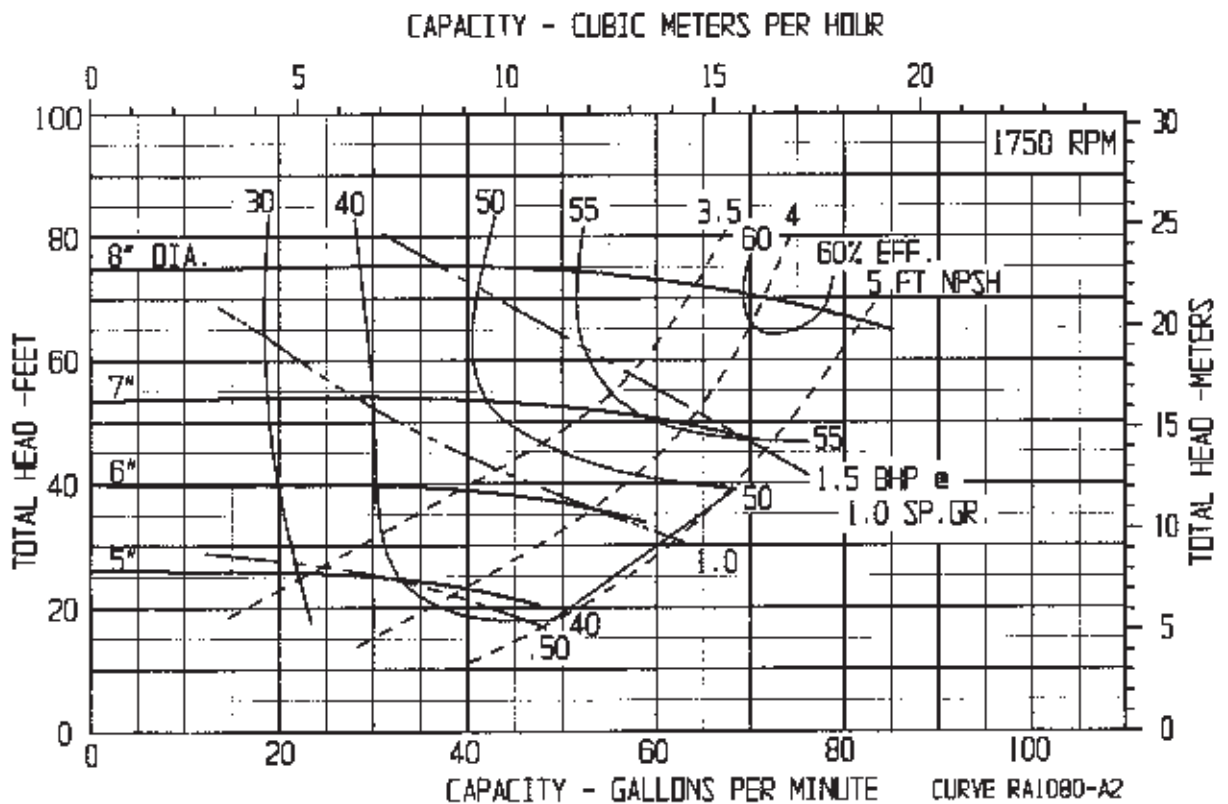
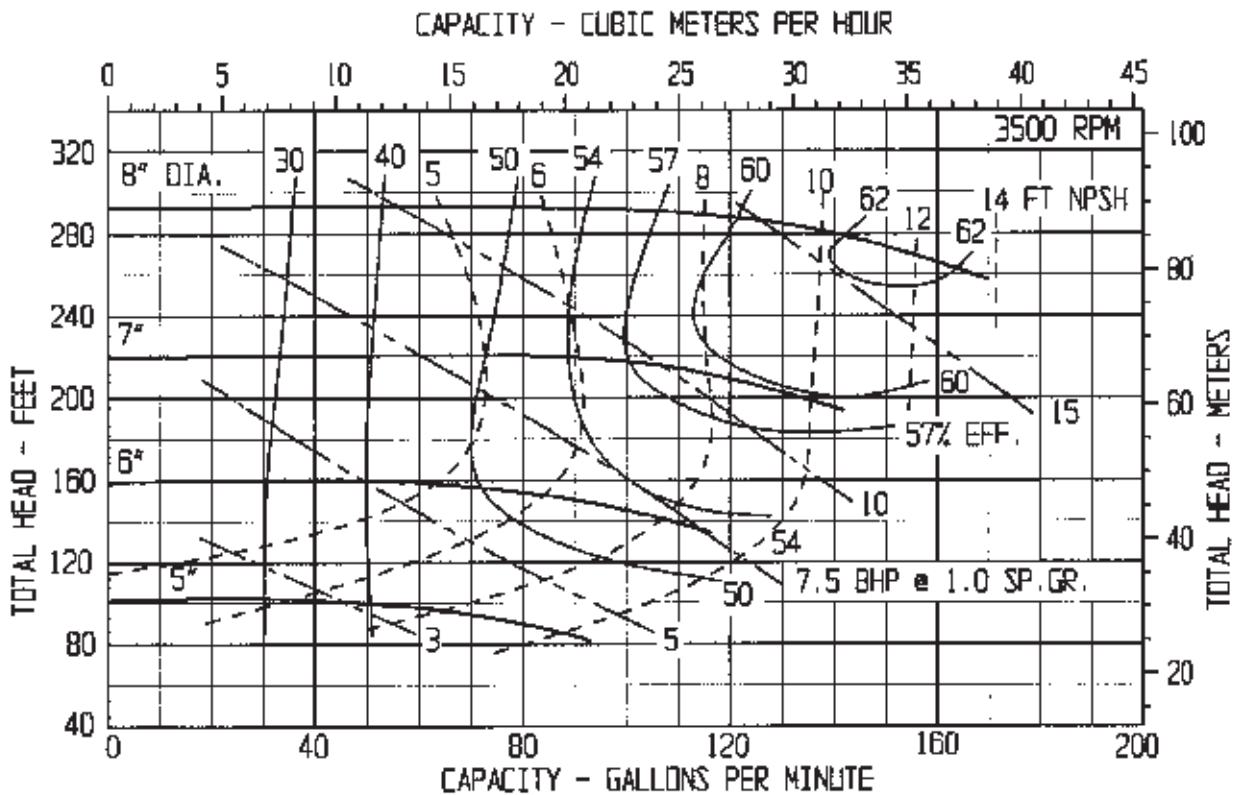

CURVE RA1080-A2

PUMP PERFORMANCE: This curve, based on extensive tests, defines the average performance of this pump for liquids having a viscosity of 70 SSU or less. Actual performance of individual units may differ slightly from the performance indicated on this curve. Pump applications made from the data contained herein are subject to confirmation and acceptance by our Engineering Department at our Indianapolis Office.

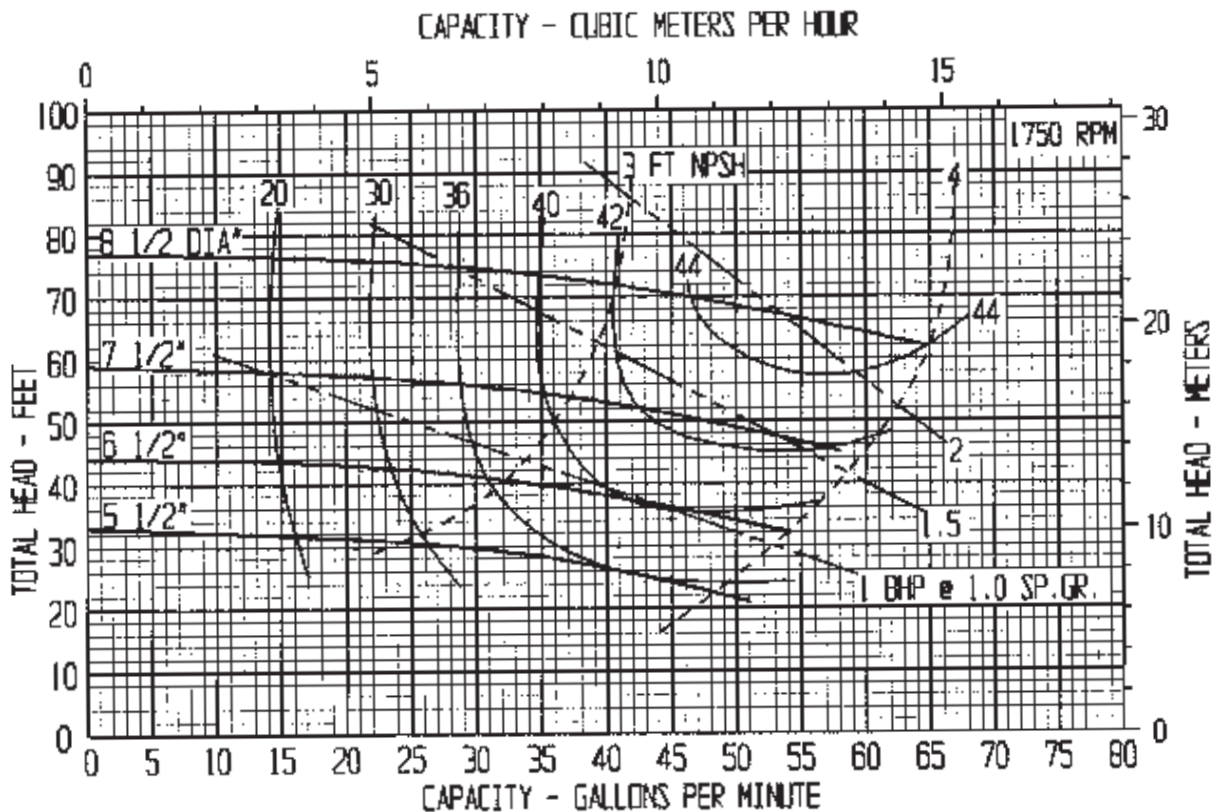
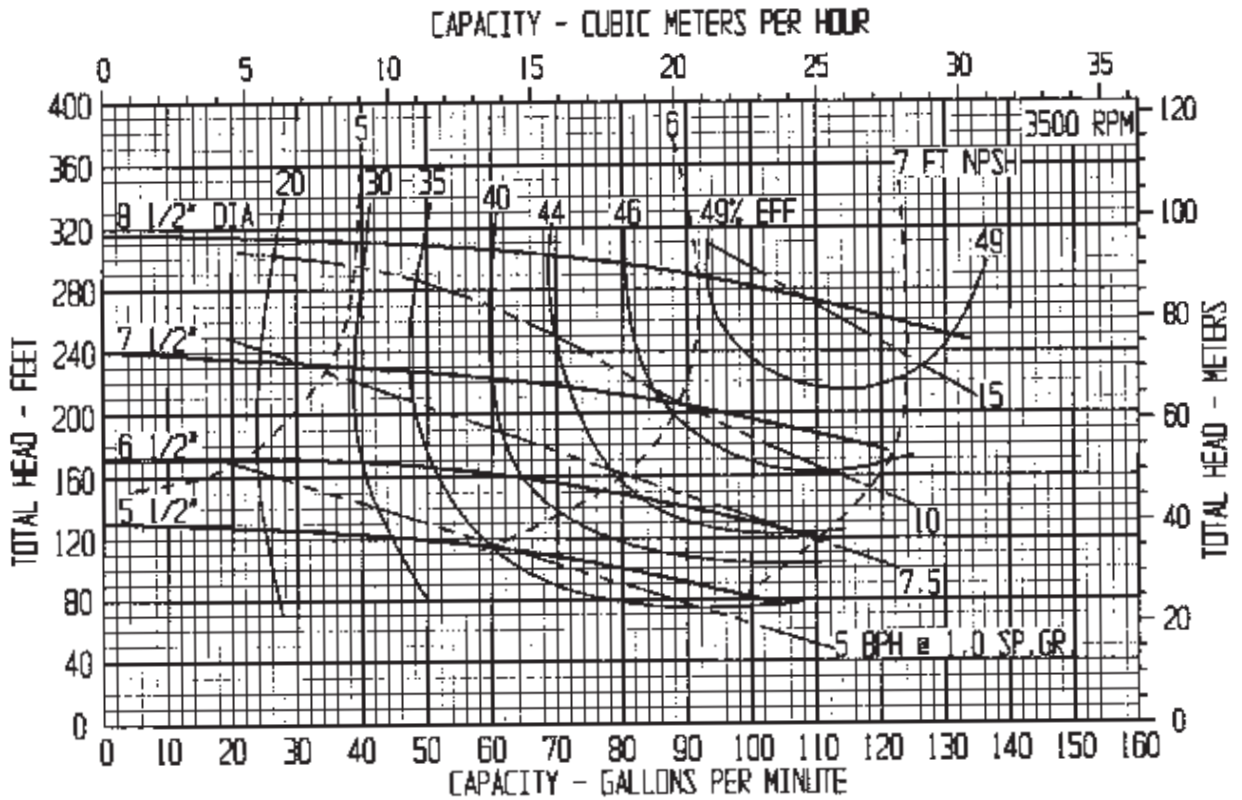

PUMP PERFORMANCE: This curve, based on extensive tests, defines the average performance of this pump for liquids having a viscosity of 70 SSU or less. Actual performance of individual units may differ slightly from the performance indicated on this curve. Pump applications made from the data contained herein are subject to confirmation and acceptance by our Engineering Department at our Indianapolis Office.

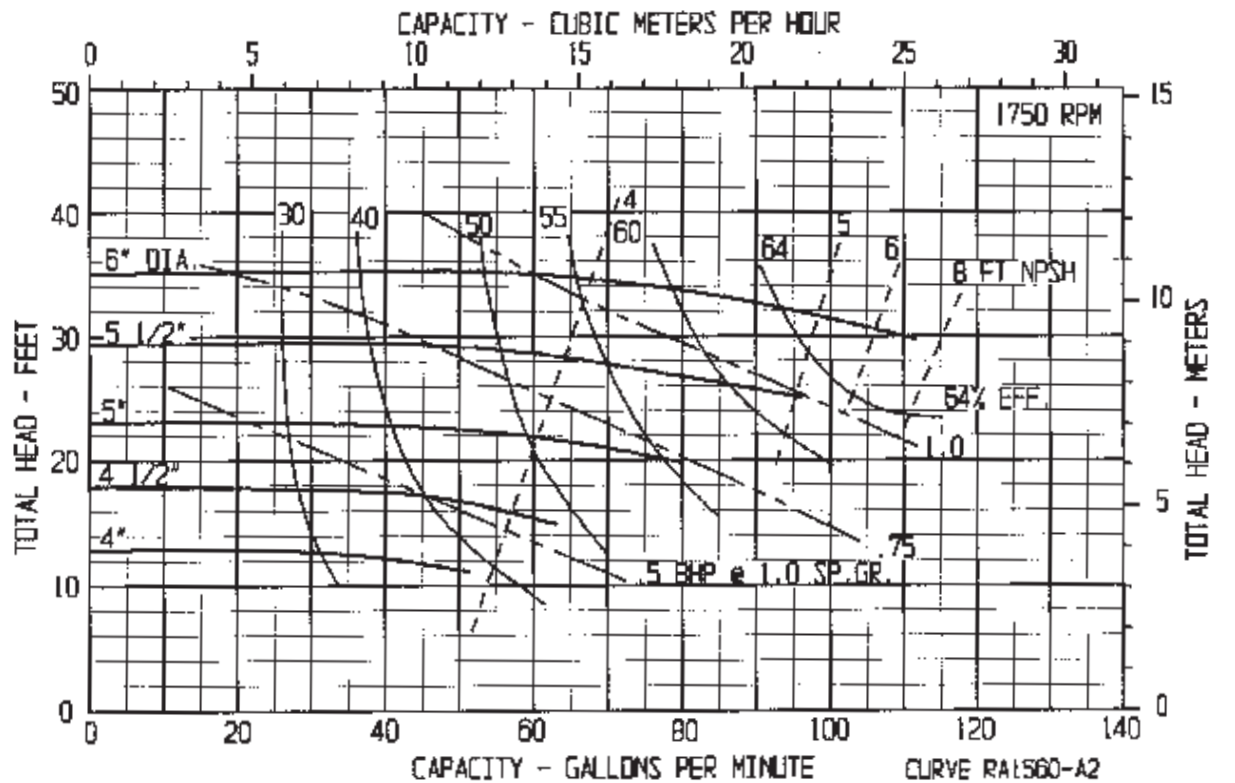
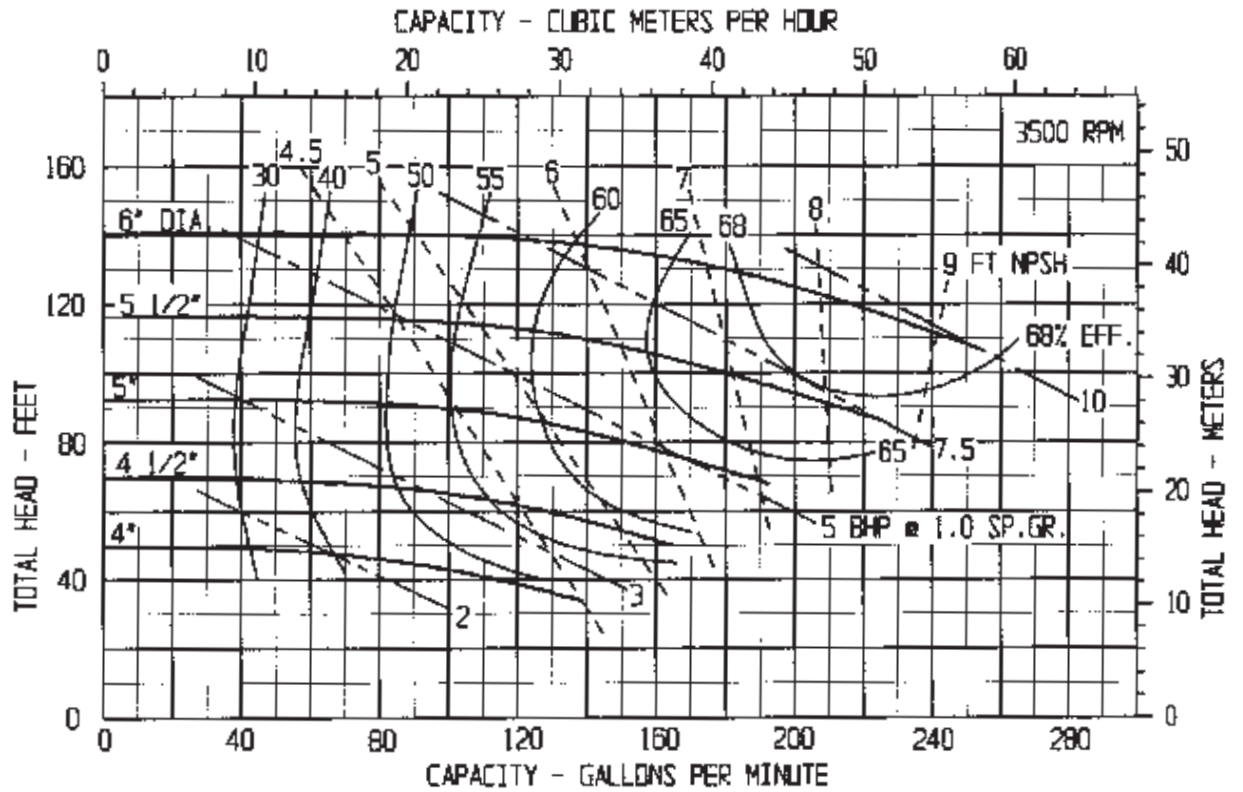

PUMP PERFORMANCE: This curve, based on extensive tests, defines the average performance of this pump for liquids having a viscosity of 70 SSU or less. Actual performance of individual units may differ slightly from the performance indicated on this curve. Pump applications made from the data contained herein are subject to confirmation and acceptance by our Engineering Department at our Indianapolis Office.

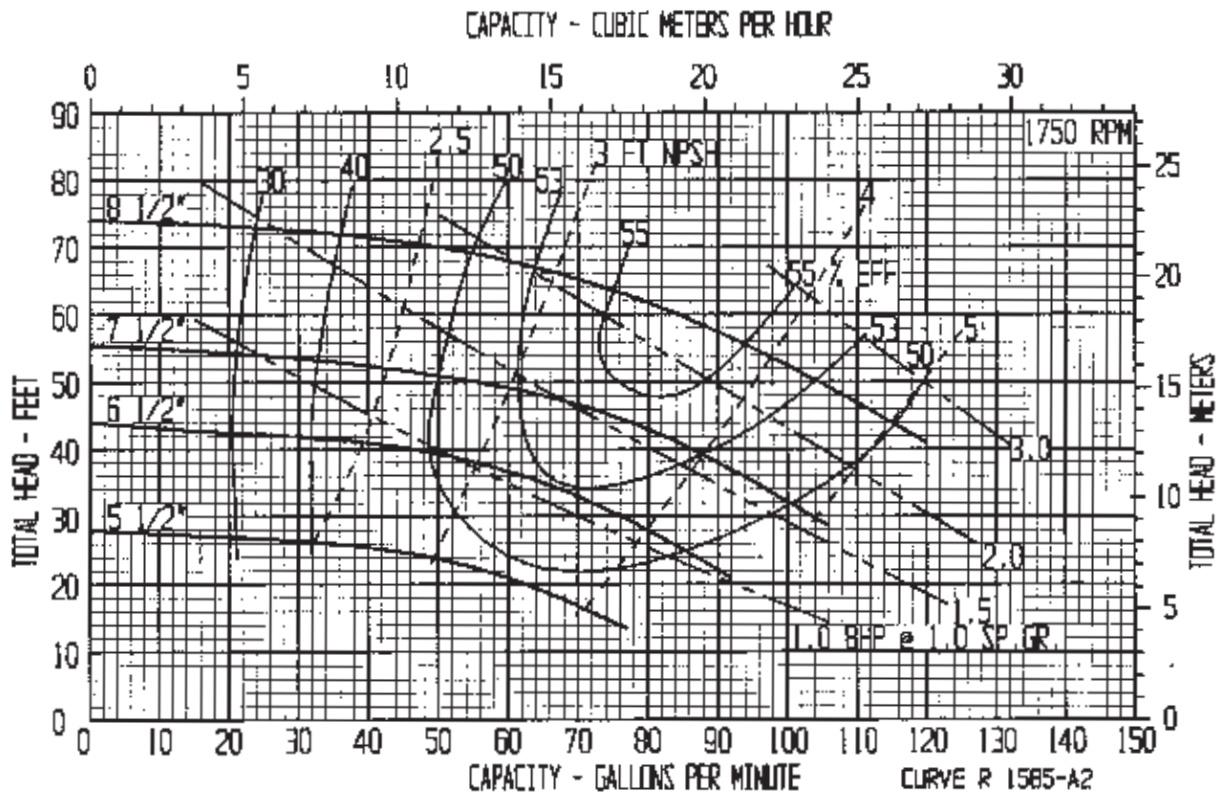
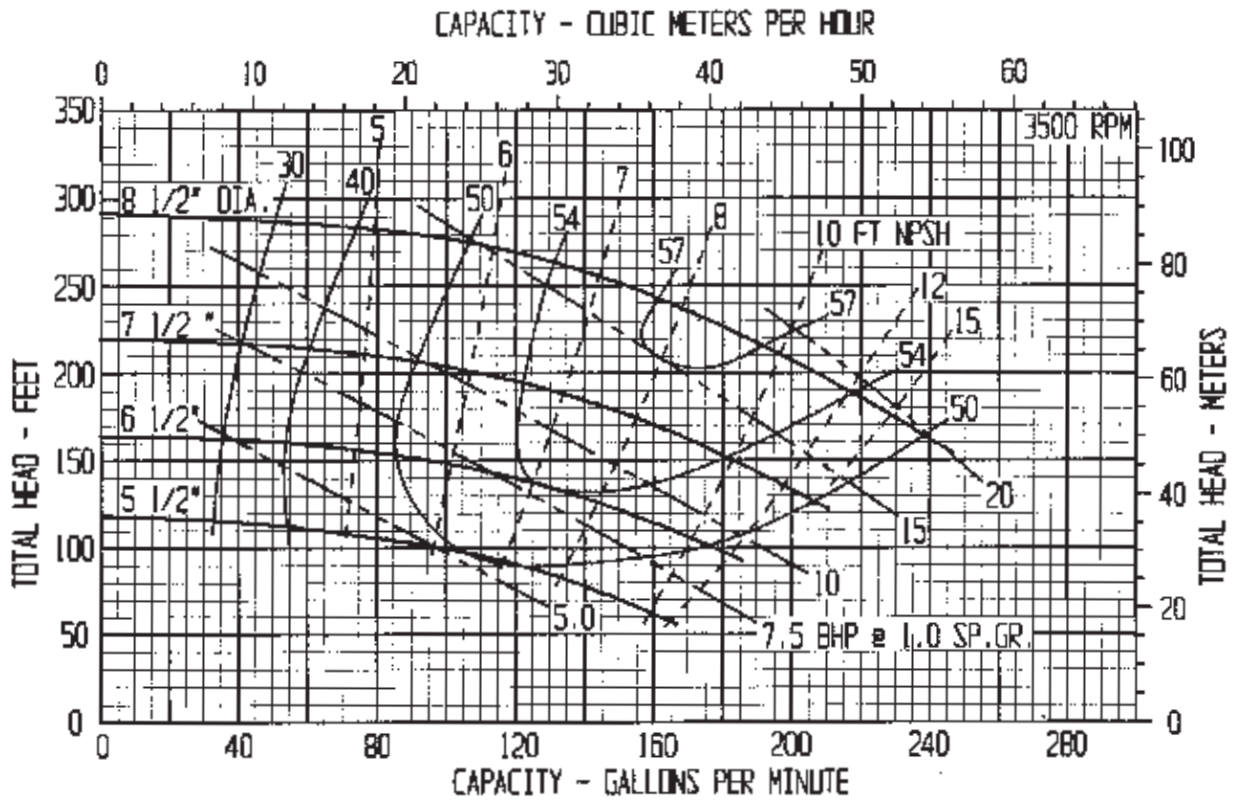

CURVE R 1585-A2

PUMP PERFORMANCE: This curve, based on extensive tests, defines the average performance of this pump for liquids having a viscosity of 70 SSU or less. Actual performance of individual units may differ slightly from the performance indicated on this curve. Pump applications made from the data contained herein are subject to confirmation and acceptance by our Engineering Department at our Indianapolis Office.

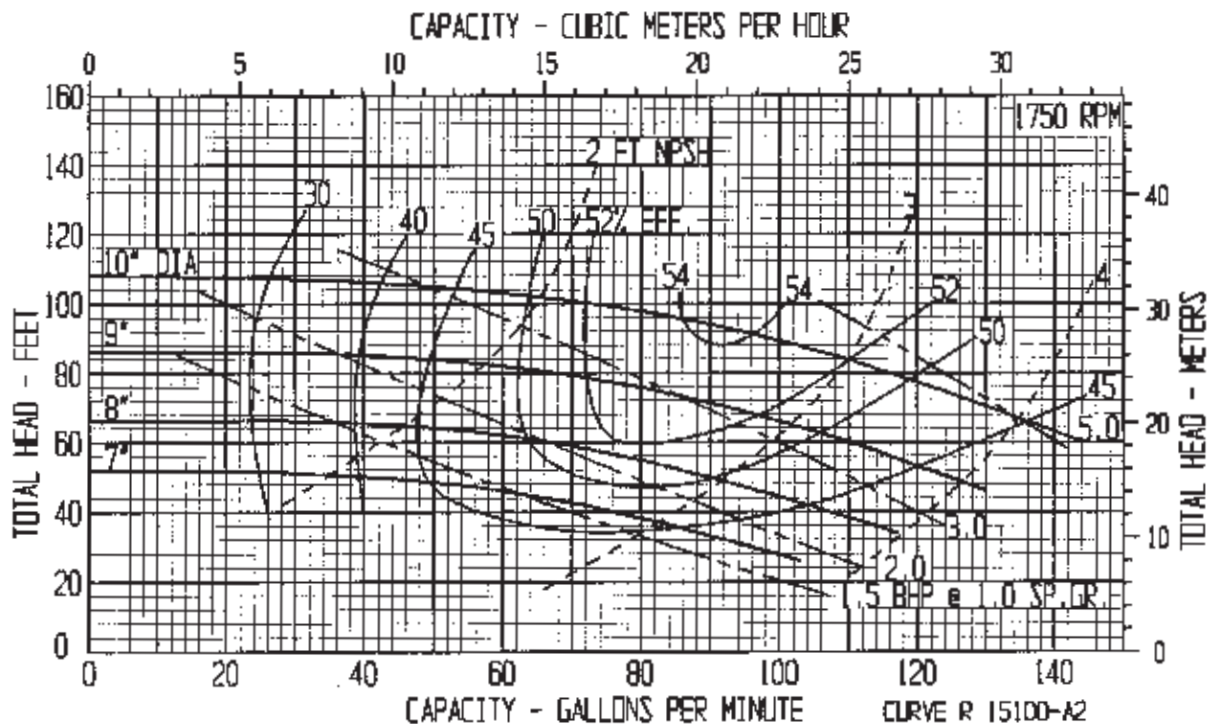
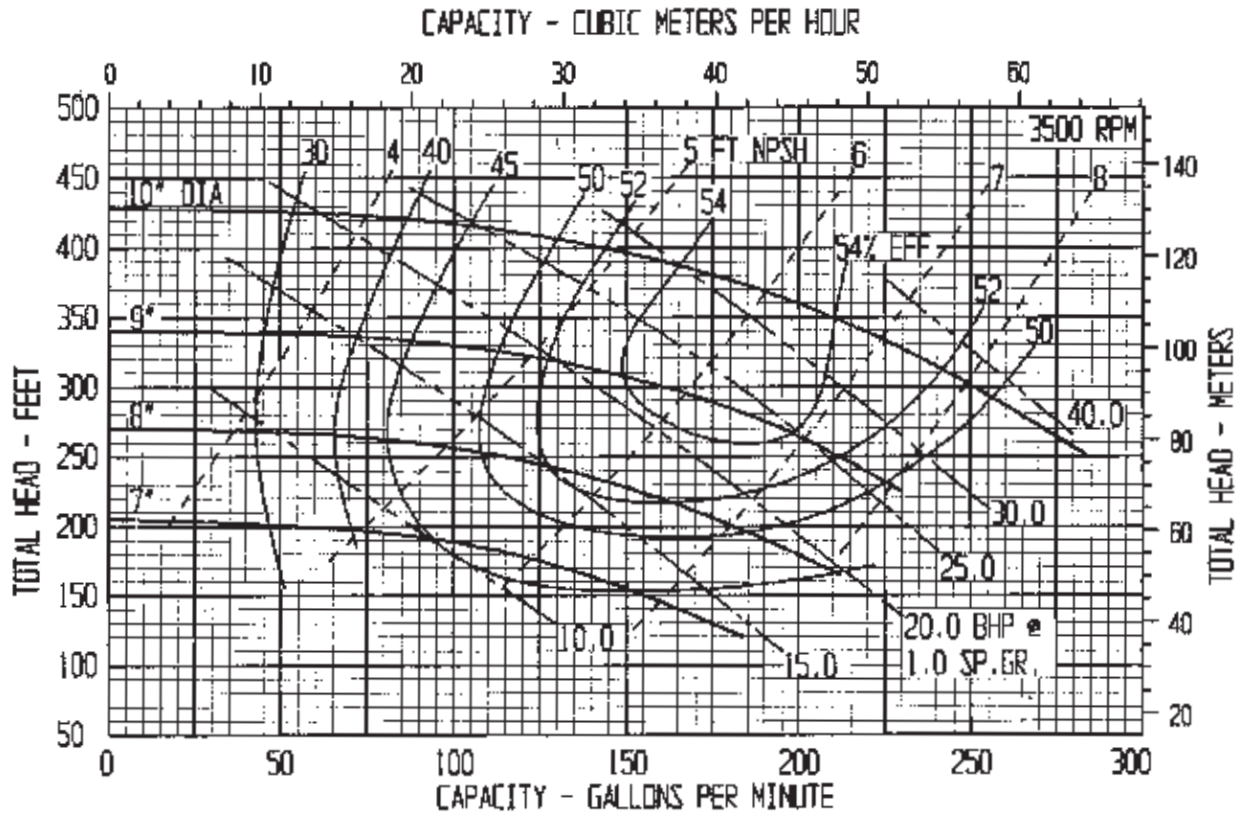

PUMP PERFORMANCE: This curve, based on extensive tests, defines the average performance of this pump for liquids having a viscosity of 70 SSU or less. Actual performance of individual units may differ slightly from the performance indicated on this curve. Pump applications made from the data contained herein are subject to confirmation and acceptance by our Engineering Department at our Indianapolis Office.

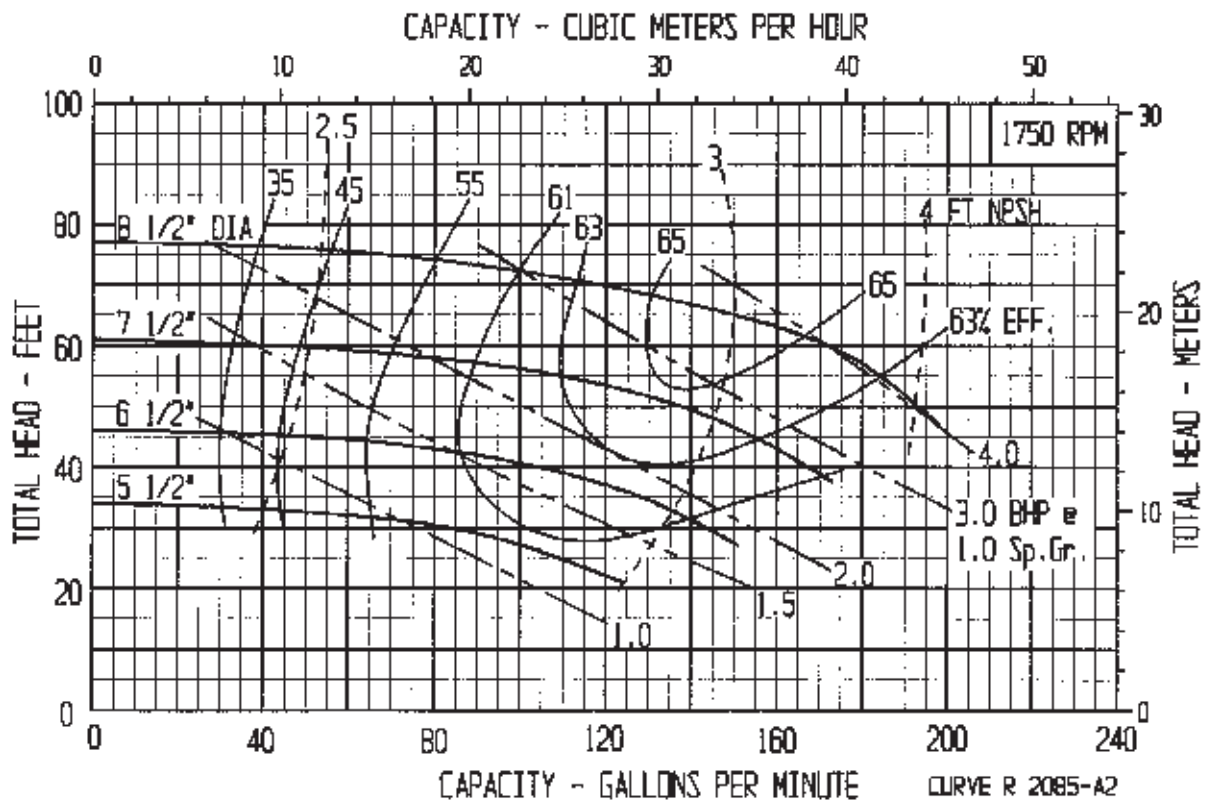
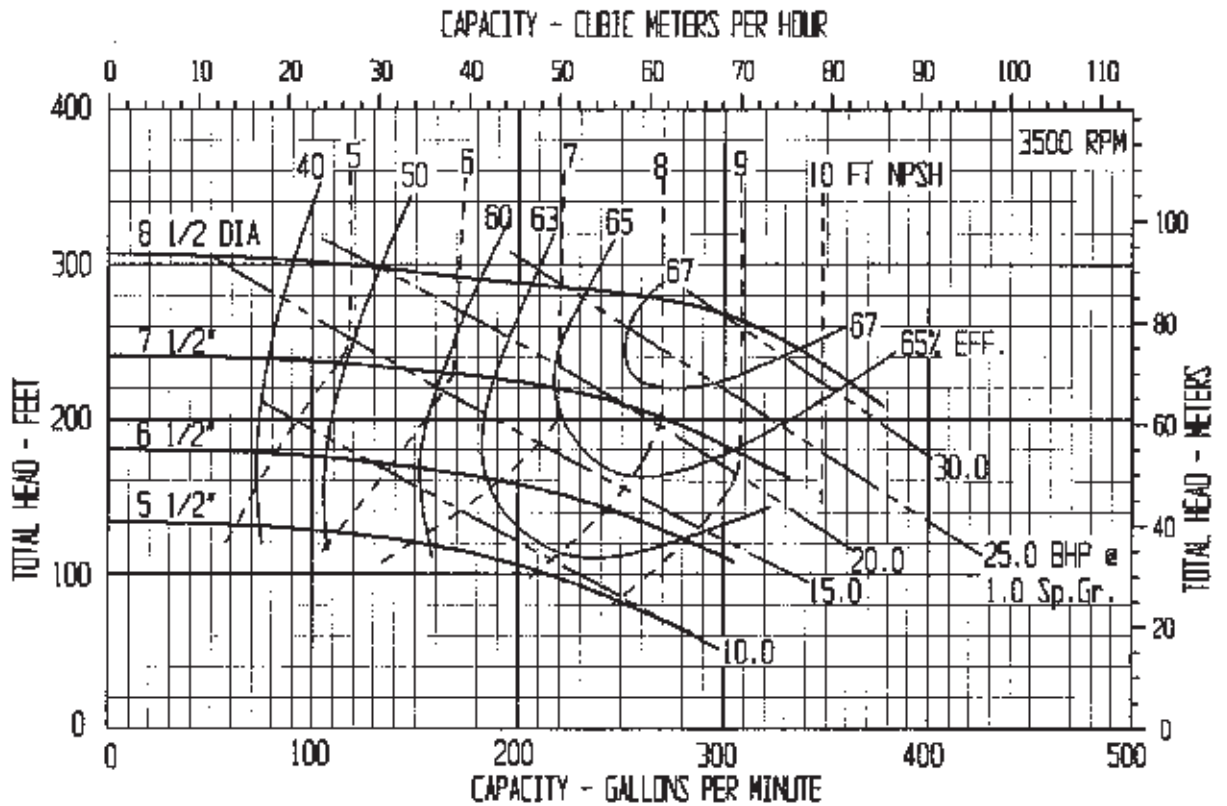

CURVE R 2085-A2

PUMP PERFORMANCE: This curve, based on extensive tests, defines the average performance of this pump for liquids having a viscosity of 70 SSU or less. Actual performance of individual units may differ slightly from the performance indicated on this curve. Pump applications made from the data contained herein are subject to confirmation and acceptance by our Engineering Department at our Indianapolis Office.

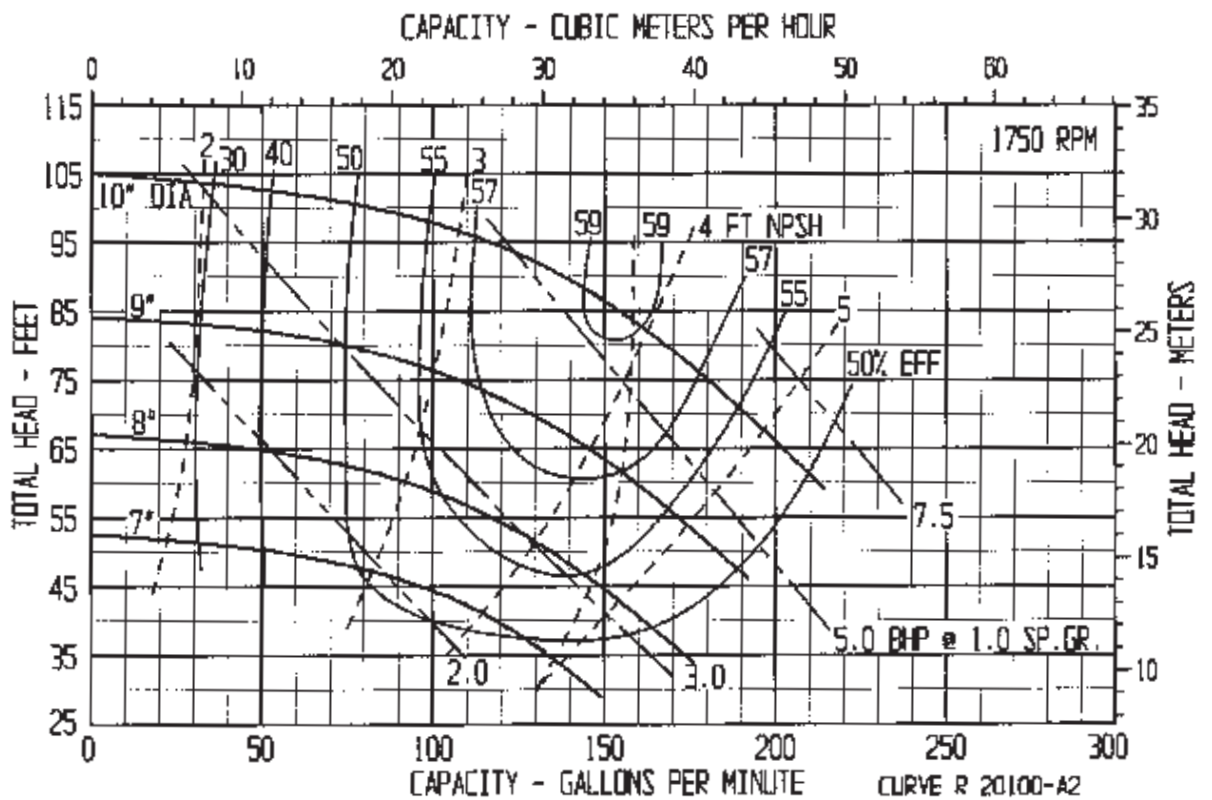
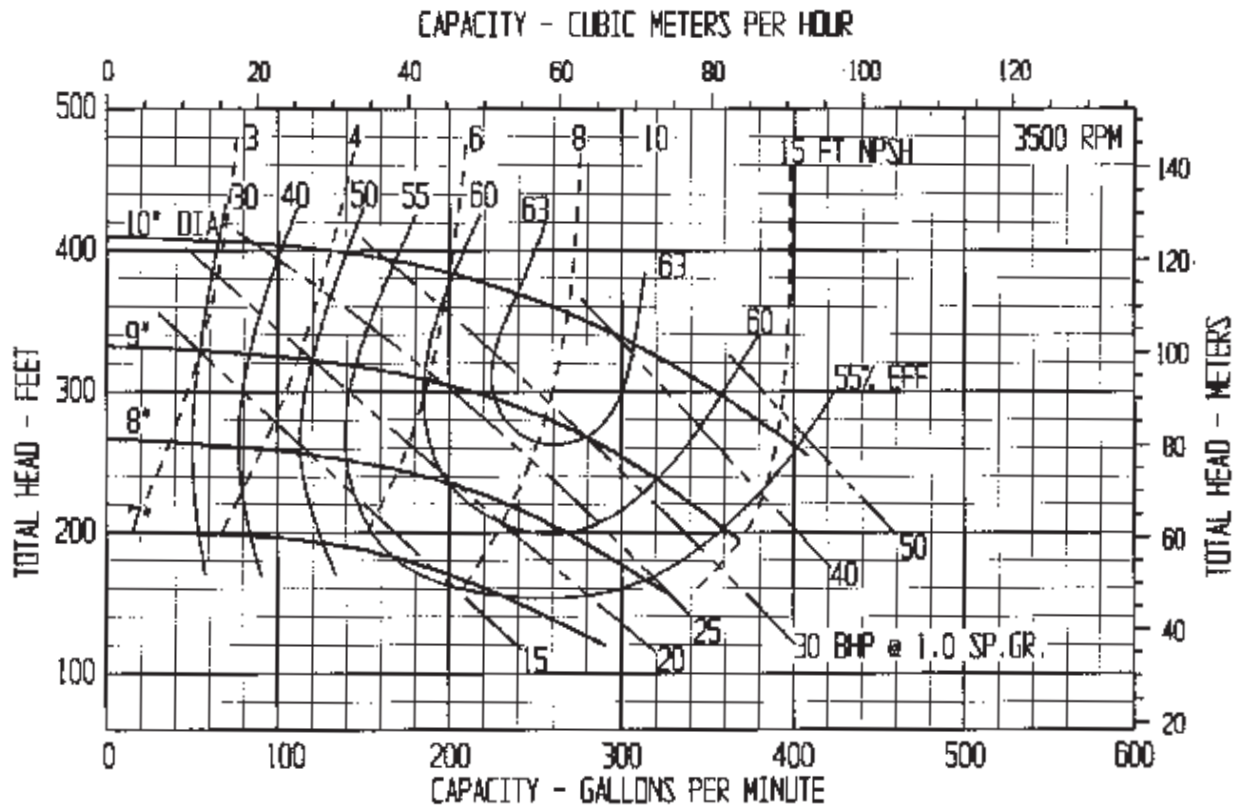

CURVE R 20100-A2

PUMP PERFORMANCE: This curve, based on extensive tests, defines the average performance of this pump for liquids having a viscosity of 70 SSU or less. Actual performance of individual units may differ slightly from the performance indicated on this curve. Pump applications made from the data contained herein are subject to confirmation and acceptance by our Engineering Department at our Indianapolis Office.

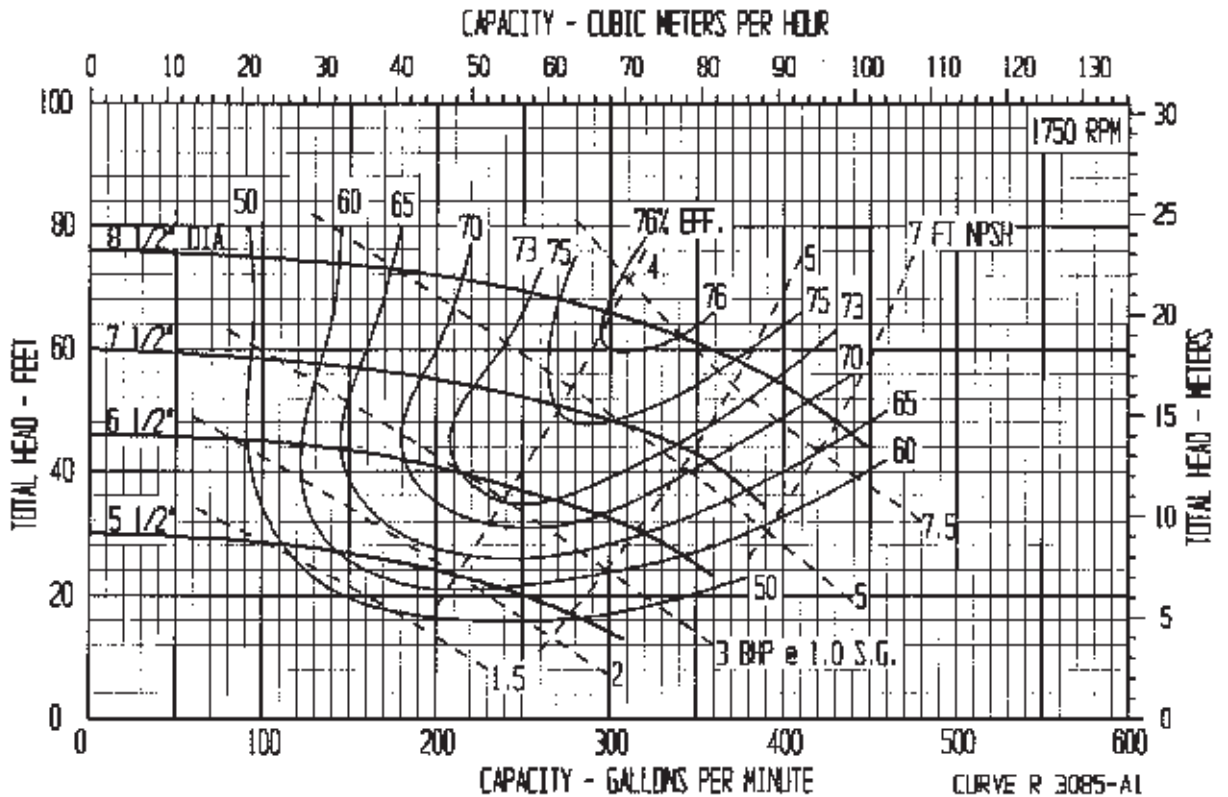
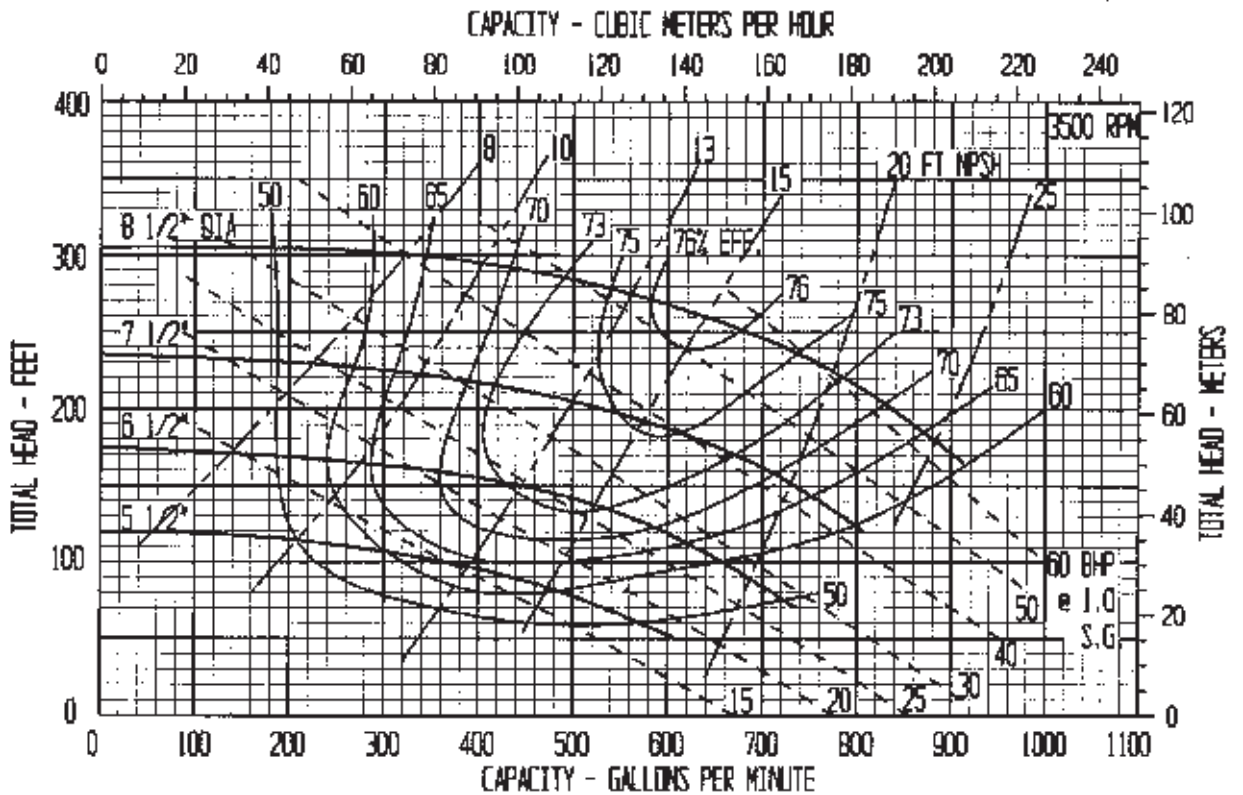

CURVE R 3085-A1

PUMP PERFORMANCE: This curve, based on extensive tests, defines the average performance of this pump for liquids having a viscosity of 70 SSU or less. Actual performance of individual units may differ slightly from the performance indicated on this curve. Pump applications made from the data contained herein are subject to confirmation and acceptance by our Engineering Department at our Indianapolis Office.

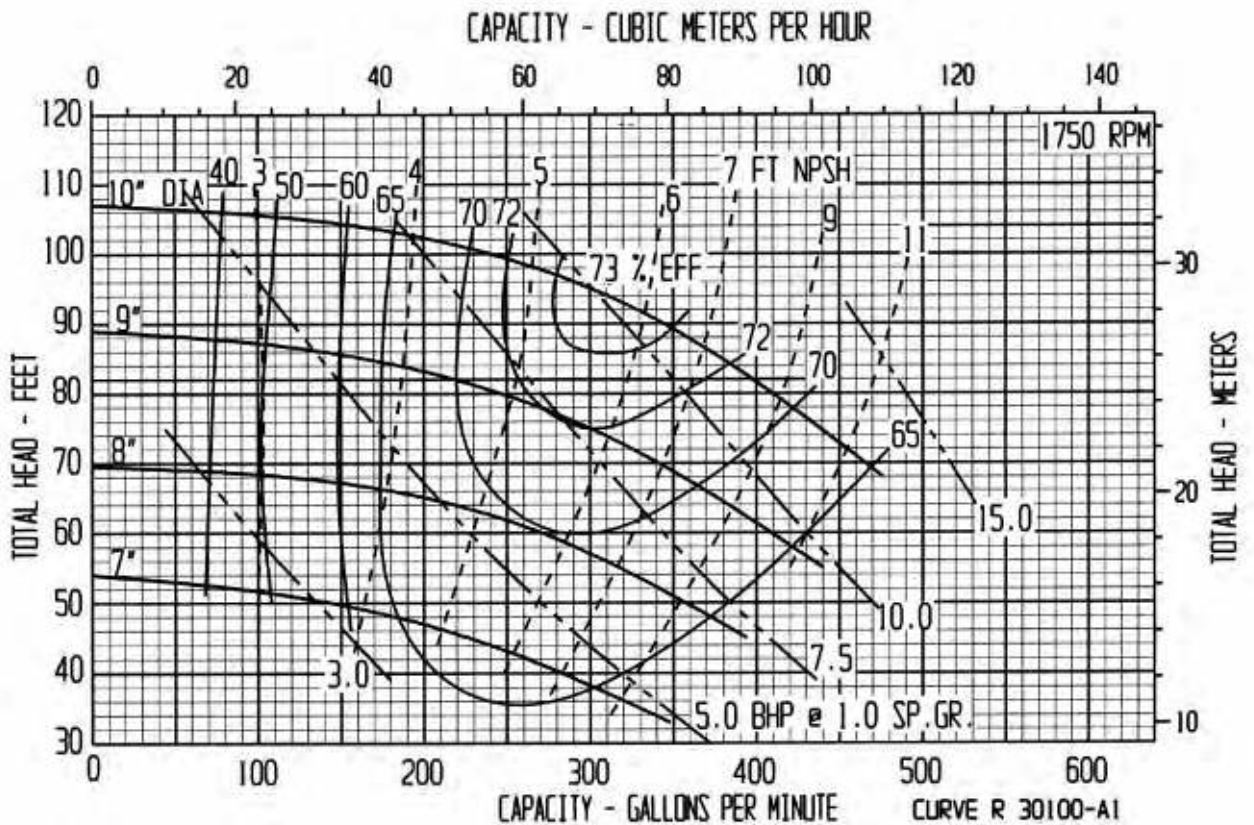
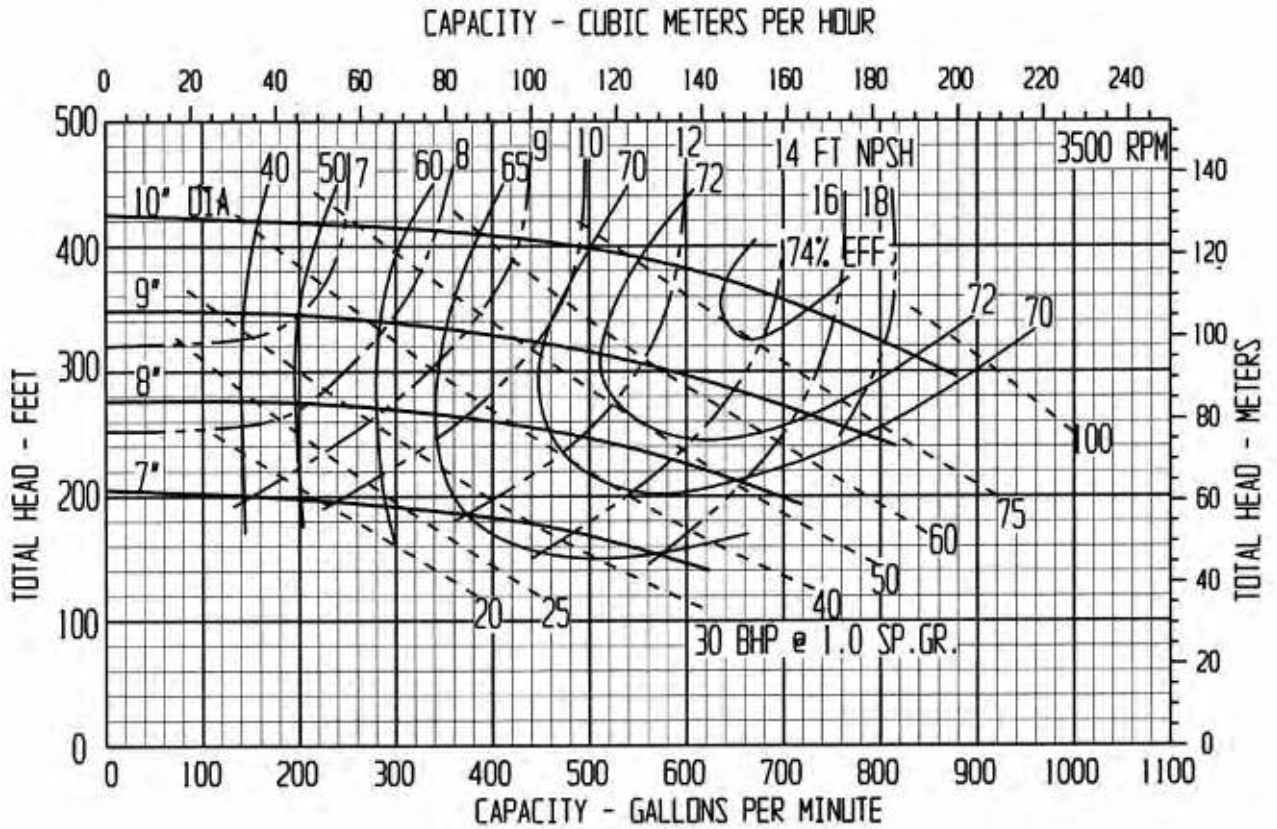

PUMP PERFORMANCE: This curve, based on extensive tests, defines the average performance of this pump for liquids having a viscosity of 70 SSU or less. Actual performance of individual units may differ slightly from the performance indicated on this curve. Pump applications made from the data contained herein are subject to confirmation and acceptance by our Engineering Department at our Indianapolis Office.

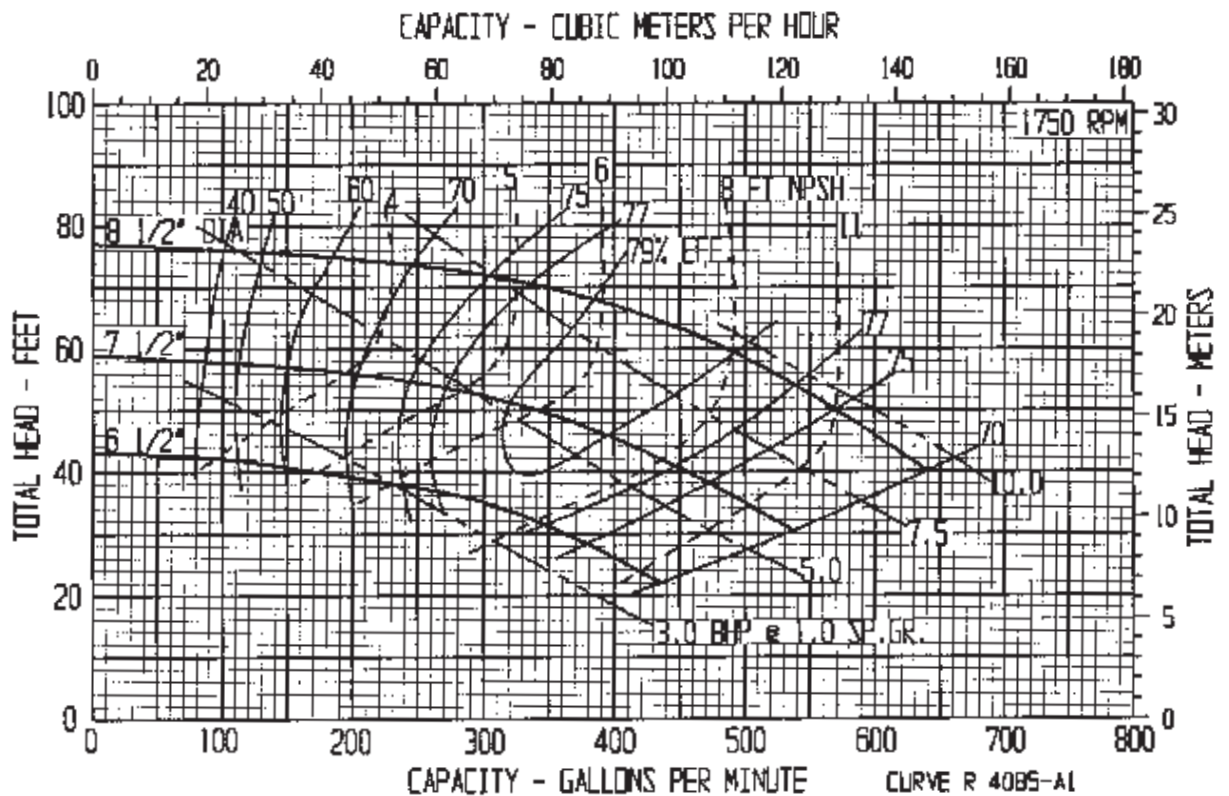
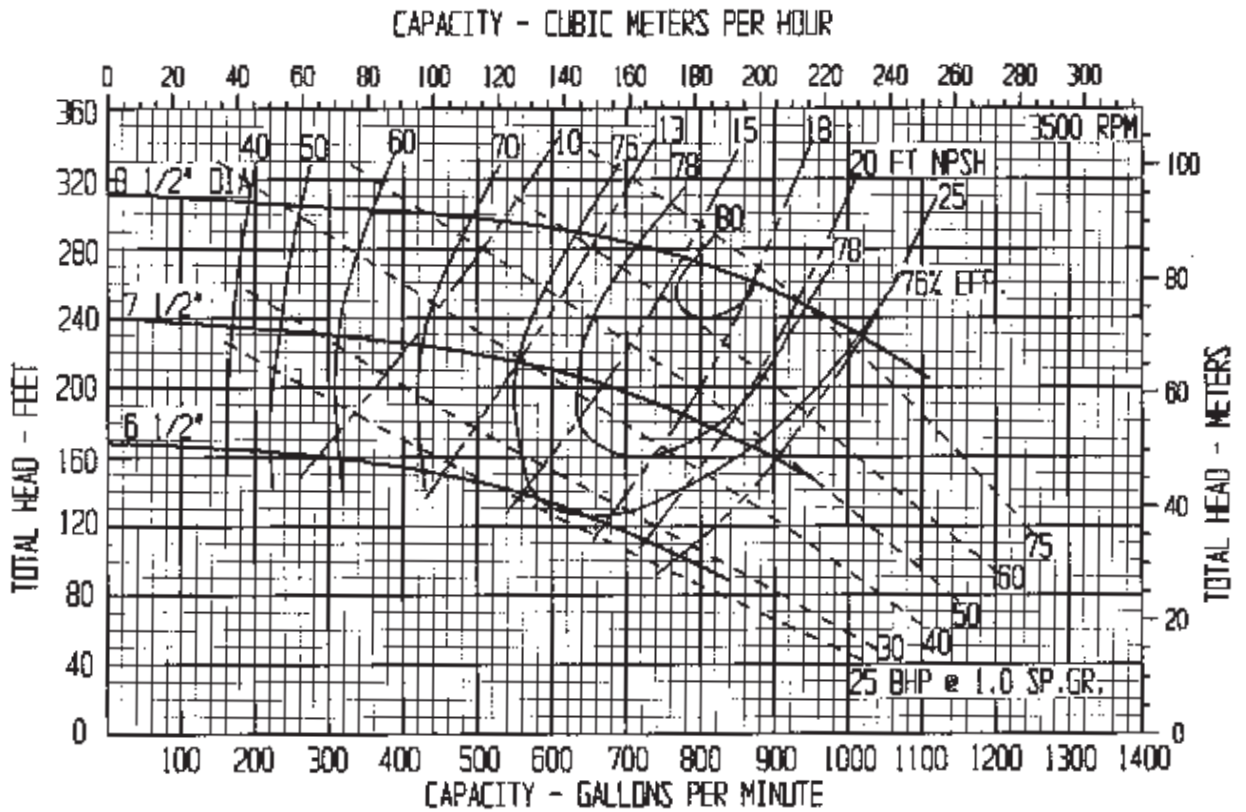

PUMP PERFORMANCE: This curve, based on extensive tests, defines the average performance of this pump for liquids having a viscosity of 70 SSU or less. Actual performance of individual units may differ slightly from the performance indicated on this curve. Pump applications made from the data contained herein are subject to confirmation and acceptance by our Engineering Department at our Indianapolis Office.

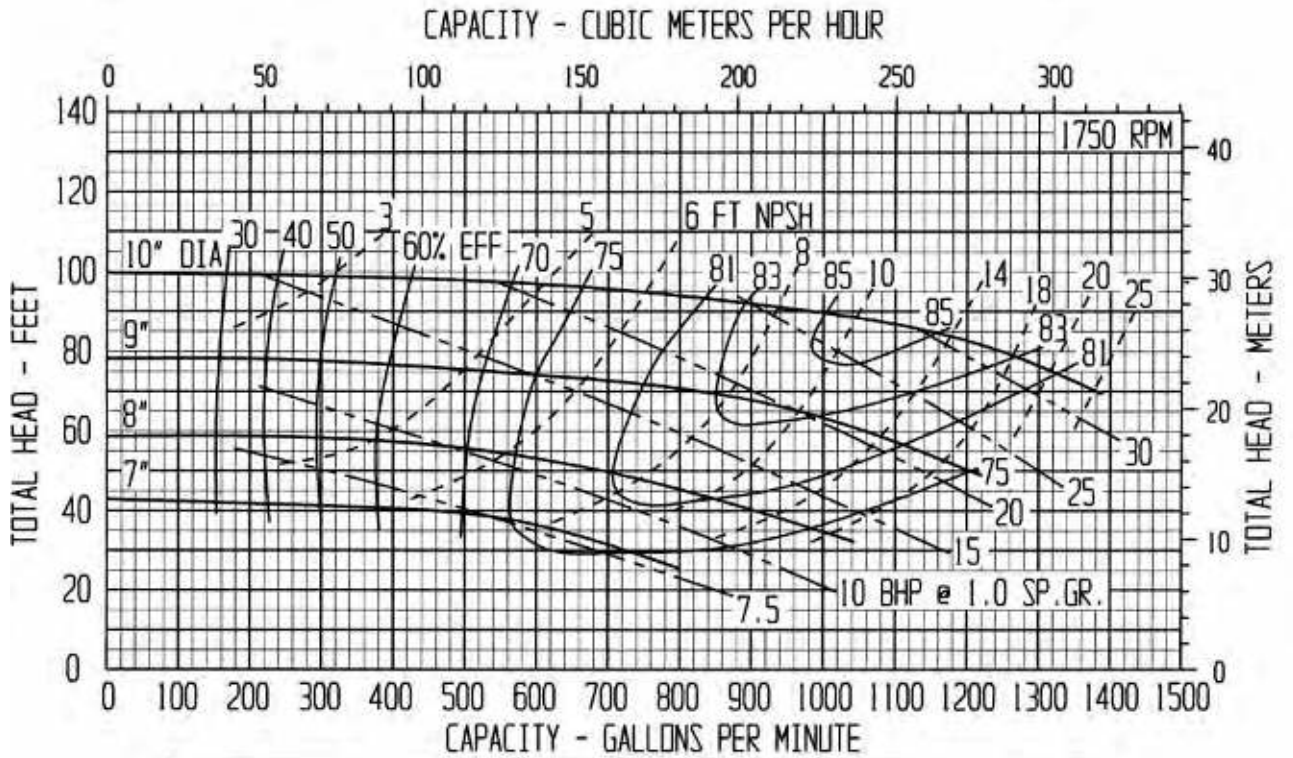

CUSTOMER	_____	ITEM No.	_____
CUSTOMER'S ORDER No.	_____	FACTORY ORDER No.	_____
DEAN PUMP SERIAL No.	_____		

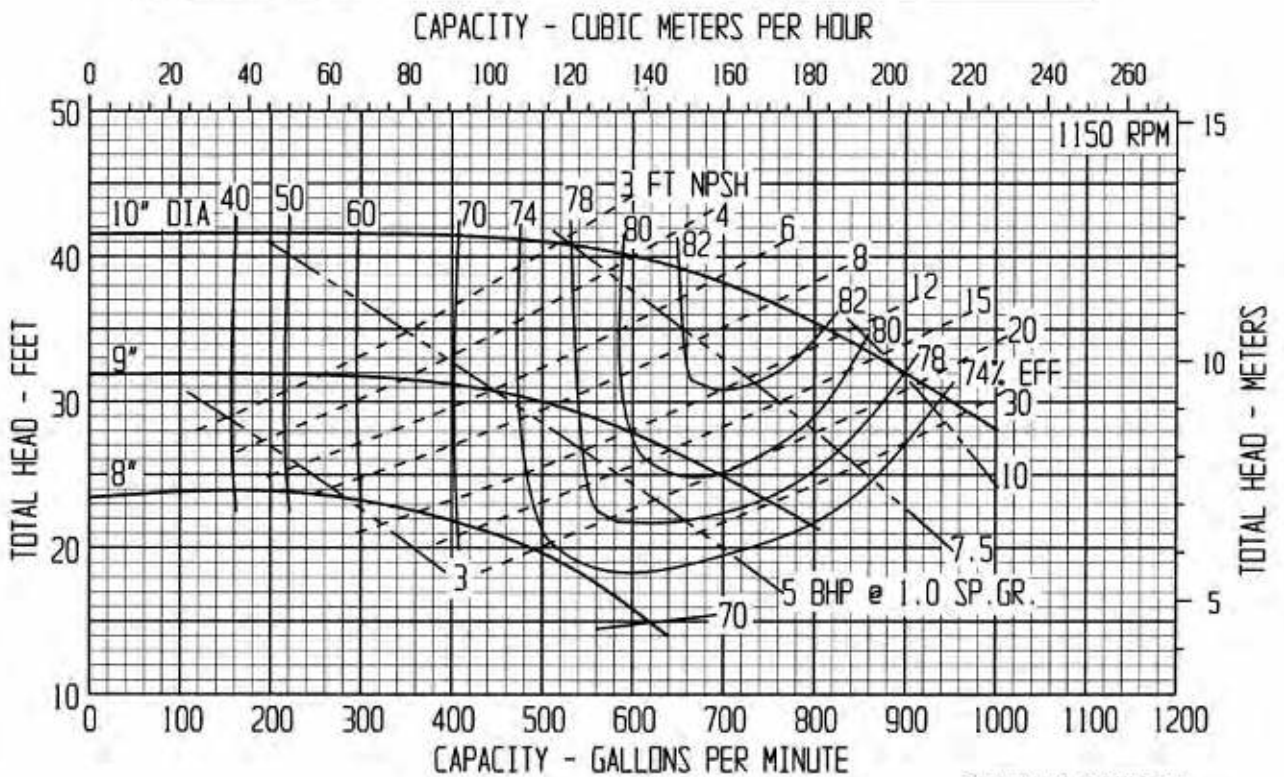

CURVE R 40100-B2

PUMP PERFORMANCE: This curve, based on extensive tests, defines the average performance of this pump for liquids having a viscosity of 70 SSU or less. Actual performance of individual units may differ slightly from the performance indicated on this curve. Pump applications made from the data contained herein are subject to confirmation and acceptance by our Engineering Department at our Indianapolis Office.

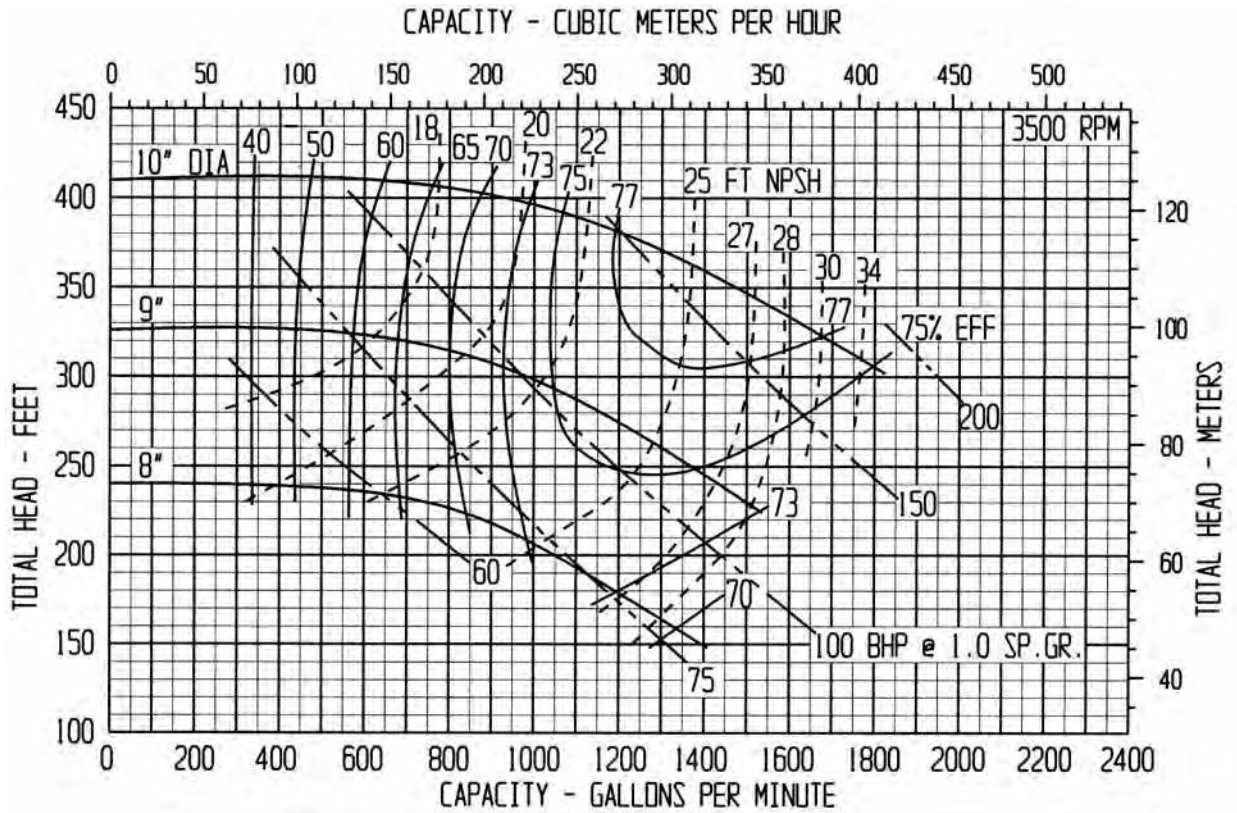

CUSTOMER _____	ITEM No. _____
CUSTOMER'S ORDER No. _____	FACTORY ORDER No. _____
DEAN PUMP SERIAL No. _____	

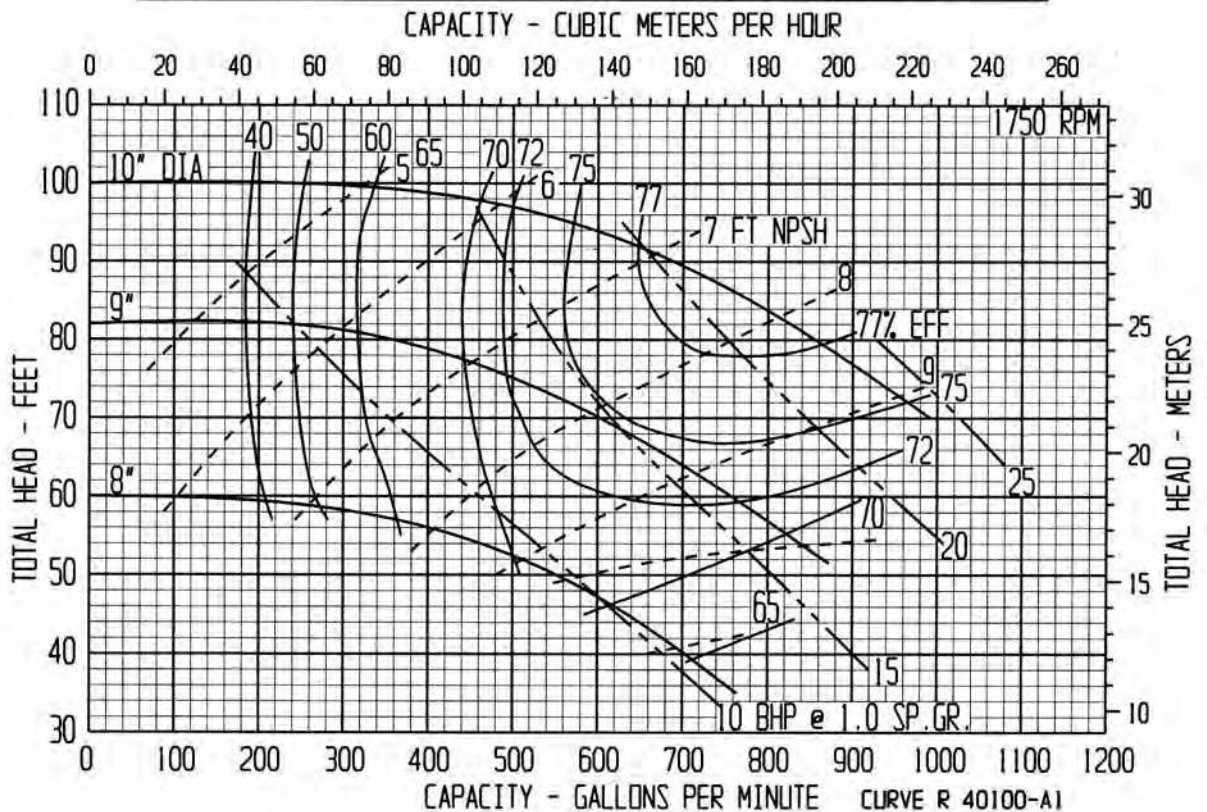



A Met-Pro Fluid Handling Technologies Business
Combining the Resources of **Dean Pump, Fybroc & Sethco**

6040 Guion Road • Indianapolis, IN 46254
(317) 293-2930 • FAX: (317) 297-7028
E-mail: info@deanpump.com • Web Site: www.deanpump.com

